

**OLYMPUS®**

---

DIGITAL VOICE  
RECORDER  
**DS-3400**  
INSTRUCTIONS

Thank you for purchasing an Olympus  
Digital Voice Recorder.  
Please read these instructions for information  
about using the product correctly and safely.  
Keep the instructions handy for future reference.

---

To ensure successful recordings, we recommend that  
you test the record function and volume before use.

**EN**

# Introduction

- The contents of this document may be changed in the future without advanced notice. Contact our Customer Support Center for the latest information relating to product names and model numbers.
- The utmost care has been taken to ensure the integrity of the contents of this document. In the unlikely event that a questionable item, error, or omission is found, please contact our Customer Support Center.
- Any liability for passive damages or damage of any kind occurred due to data loss incurred by a defect of the product, repair performed by the third party other than Olympus or an Olympus authorized service station, or any other reasons is excluded from Olympus's liability.

## Trademarks

Microsoft and Windows are registered trademarks of Microsoft Corporation.

Macintosh is a trademark of Apple Inc.

Intel and Pentium are registered trademarks of Intel Corporation.

The SD logo is a trademark.

The SDHC logo is a trademark.

Other product and brand names mentioned herein may be the trademarks or registered trademarks of their respective owners.



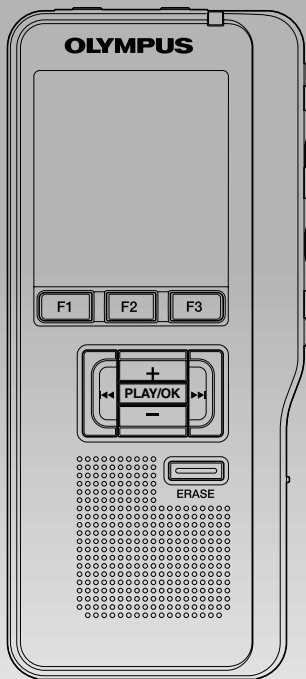

|                                    |             |
|------------------------------------|-------------|
| <b>Table of Contents</b>           | <b>P.4</b>  |
| <b>Safe and Proper Usage</b>       | <b>P.5</b>  |
| <b>Getting Started</b>             | <b>P.7</b>  |
| <b>Basic Operations</b>            | <b>P.19</b> |
| <b>Advanced Operations</b>         | <b>P.33</b> |
| <b>Managing Files on Your PC</b>   | <b>P.59</b> |
| <b>Other Practical Use Methods</b> | <b>P.67</b> |
| <b>Other Information</b>           | <b>P.68</b> |

- 1**
- 2**
- 3**
- 4**
- 5**
- 6**

# Table of Contents

---

|                             |   |
|-----------------------------|---|
| Table of Contents .....     | 4 |
| Safe and Proper Usage ..... | 5 |
| General Precautions .....   | 5 |

## 1 Getting Started

|   |    |
|---|----|
| Main Features .....                     | 7  |
| Memory Card .....                       | 8  |
| Identification of Parts .....           | 10 |
| Installing Batteries .....              | 12 |
| Power Supply .....                      | 14 |
| Power Save Mode (Power Save) .....      | 14 |
| HOLD .....                              | 15 |
| Inserting and Ejecting a SD card .....  | 16 |
| Setting Time and Date (Time & Date) ... | 17 |

## 2 Basic Operations

|   |    |
|---|----|
| Recording .....   | 19 |
| Microphone Sensitivity (Mic Sense) .....                  | 23 |
| Recording Modes (Rec Mode) .....                          | 24 |
| Using the Variable Control Voice Actuator<br>(VCVA) ..... | 25 |
| Recording Monitor .....                                   | 26 |
| Playing .....   | 27 |
| Erasing .....   | 29 |

## 3 Advanced Operations

|   |    |
|---|----|
| Menu List .....                                 | 33 |
| Learning to Use the Menu .....                  | 35 |
| Selecting Folders and Files .....               | 36 |
| Displaying File Information (Information) ..... | 37 |
| Device Lock Function .....                      | 38 |
| Locking Files (Lock) .....                      | 40 |

|   |    |
|---|----|
| Pending Files (Pending) .....               | 41 |
| Setting Priority Levels (Priority) .....    | 42 |
| Setting the Author ID and Work Type ....    | 43 |
| Verbal Comment .....                        | 46 |
| Index Marks .....                           | 47 |
| Language (Language) .....                   | 48 |
| Backlight (Backlight) .....                 | 49 |
| LED (LED) .....                             | 50 |
| LCD Contrast Adjustment (Contrast) ....     | 51 |
| System Sounds (Beep) .....                  | 52 |
| Cue/Rev Sound (Cue/Rev Sound) .....         | 53 |
| Formatting the Card (Format) .....          | 54 |
| Check System Information (System Info.) ... | 56 |
| Changing the USB Class (USB Class) ....     | 57 |
| Customizing the Recorder .....              | 58 |

## 4 Managing Files on Your PC

|  |    |
|--|----|
| DSS Player Software .....              | 59 |
| Installing DSS Player Software .....   | 61 |
| Uninstalling DSS Player Software ..... | 62 |
| Using Online Help .....                | 63 |
| Connecting Recorder to PC .....        | 64 |
| Running DSS Player Software .....      | 66 |

## 5 Other Practical Use Methods

|  |    |
|--|----|
| Using as External Memory of the Computer ... | 67 |
|--|----|

## 6 Other Information

|  |    |
|--|----|
| Alarm Message List .....               | 68 |
| Troubleshooting .....                  | 69 |
| Accessories .....                      | 70 |
| Specifications .....                   | 71 |
| Technical Assistance and Support ..... | 72 |

# Safe and Proper Usage

---

Before using your new recorder, read this manual carefully to ensure that you know how to operate it safely and correctly. Keep this manual in an easily accessible location for future reference.

- The warning symbols indicate important safety related information. To protect yourself and others from personal injury or damage to property, it is essential that you always read the warnings and information provided.

## Convention Used In this Manual

---

- The word “card” is used to refer to the SD card.
- The word “DSS Player” is used to refer to the DSS Player Pro Dictation Module in Windows environment and DSS Player in Apple Macintosh environment.
- The Notes at the bottom of a page are used for additional information, exceptions, or related events.
- Words in uppercase form such as PLAY or REC are used to describe a function or button on the recorder.

# General Precautions

---

- Do not leave the recorder in hot, humid locations such as inside a closed automobile under direct sunlight or on the beach in the summer.
- Do not store the recorder in places exposed to excessive moisture or dust.
- Do not use organic solvents such as alcohol and lacquer thinner to clean the unit.
- Do not place the recorder on top of or near electric appliances such as TVs or refrigerators.
- Avoid recording or playing back near cellular phones or other wireless equipment, as they may cause interference and noise. If you experience noise, move to another place, or move the recorder further away from such equipment.
- Avoid sand or dirt. These can cause irreparable damage.
- Avoid strong vibrations or shocks.
- Do not disassemble, repair or modify the unit yourself.
- Do not operate the unit while operating a vehicle (such as a bicycle, motorcycle, or go-cart).
- Keep the unit out of the reach of children.

### <Warning regarding data loss>

Recorded content in memory may be destroyed or erased by operating mistakes, unit malfunction, or during repair work.

It is recommended to back up and save important content to other media such as a computer hard disk.

### Batteries

---

#### **Danger**

- Do not solder lead wires or terminals directly onto a battery or modify it.
- Do not connect the ⊕ and ⊖ terminals together. This may cause fire, overheating or electric shock.
- When carrying or storing the battery, be sure to put it in the provided case to protect its terminals. Do not carry or store the battery with any metal objects (such as key rings). If this warning is not followed, fire, overheating or electric shock may occur.
- Do not connect the batteries directly to a power outlet or a cigarette lighter of an automobile.
- Do not insert the batteries with their ⊕ and ⊖ terminals reversed.
- If any liquid from a battery gets into your eyes, promptly wash it off with clean water and consult your doctor at once.
- There is a hole from which gas escapes on the ⊕ terminal. Do not cover or block it.

#### **Warning**

- Batteries should never be exposed to flame, heated, short-circuited or disassembled.
- Do not attempt to recharge alkaline, lithium or any other non-rechargeable batteries.

- Never use any battery with a torn or cracked outer cover.
- Keep batteries out of the reach of children.
- If you notice anything unusual when using this product such as abnormal noise, heat, smoke, or a burning odor:
  - ① remove the batteries immediately while being careful not to burn yourself, and;
  - ② call your dealer or local Olympus representative for service.
- Do not expose the batteries to water. Do not allow water to contact the terminals.
- Do not remove or damage the battery insulating sheet.
- Do not use the batteries if you find something wrong with them such as leakage, color change or deformity.
- Should any battery liquid get on skin or clothing, promptly wash it off with clean water.
- Keep batteries away from fire.

#### **Caution**

- Do not subject batteries to strong shocks.
- Do not use batteries of different types, voltages, and/or brand names.

# 1 Getting Started

## Main Features

---

- Support type of memory: SD card (☞ P.8).
- Three Programmable smart buttons F1, F2 and F3 (☞ P.58).
- Recording and storing voice in Digital Speech Standard Pro (DS2 format).
- Two recording modes, QP (Quality Playback) mode or SP (Standard Playback) mode (☞ P.24).
- Data encryption function for securing recordings on the device.
- Overwrite Recording and Insert Recording (partial insertion) available (☞ P.21, 22).
- Supports USB 2.0. High-Speed, which enables high-speed data transmission from the recorder to your computer.
- Five folders and up to 200 files/folder, for a maximum of 1000 recordings (☞ P.19).  
When using DSS Player, it is possible to create up to a maximum of seven folders (1,400 files) (☞ P.58, 59).
- It has a built-in Variable Control Voice Actuator (VCVA) function (☞ P.25).
- Large LCD screen with backlight.
- Device Lock function to prevent unauthorized access to device (☞ P.58).  
Authentication system via password (☞ P.38, 39).
- Index mark function which is useful to search particular points in the dictation (☞ P.47).
- Verbal comment function which allows transcriptionists to instantly search and play back instructions on their computer (☞ P.46).
- Priority Setting (☞ P.42).
- DSS Player software included (☞ P.59).  
It is possible to customize the recorder in a number of ways.

# Memory Card

This recorder uses memory in the form of SD card memory.

## Compatible Cards

The recorder supports cards with memory capacity between 512 MB to 16 GB.

### Settings and operating environment relating to the card

Check the latest operating information on the Olympus homepage (<http://www.olympus.com>) when using cards other than the included card. In addition, refer to the following pages as well when handling the card.

- Inserting and Ejecting a SD card (P.16)
- Formatting the Card (Format) (P.54)

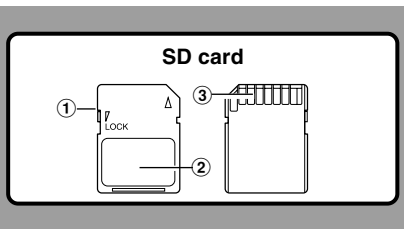

## SD card

### ① Card Lock

SD card is equipped with a lock function. When the lock function is used, important data is protected by preventing it from being accidentally overwritten or erased. When the lock function is set  will appear on the display.

### ② Index Area

For writing down information identifying card or content.

### ③ Contact Area

Comes into contact with the recorder's signal read contacts.

## Memory Sizes of Cards and Approximate Recording Times\*1

| Memory Size | QP Mode            | SP Mode            |
|-------------|--------------------|--------------------|
| 512MB       | 38 hr. 30 min.     | 79 hr. 00 min.     |
| 1GB         | 77 hr. 00 min.     | 157 hr. 50 min.*2  |
| 2GB         | 152 hr. 30 min.*2  | 312 hr. 20 min.*2  |
| 4GB         | 305 hr. 50 min.*2  | 626 hr. 50 min.*2  |
| 8GB         | 624 hr. 30 min.*2  | 1279 hr. 30 min.*2 |
| 16GB        | 1248 hr. 10 min.*2 | 2557 hr. 10 min.*2 |

The above are the standard times, and the available recording time will vary depending on the card.

\*1: Available recording time for one continuous file. Available recording time may be shorter if many short recordings are made.

\*2: Total recording time of several files. The maximum recording time per file is 99 hours 59 minutes.



**Warning**

- Do not touch the card contacts. That may damage the card.



- Do not place the card in locations with static electricity.



- Store the card in a location that is out of the reach of children. In case of accidental ingestion, consult a physician immediately.

**Check Card Information (Card Info.)**

Information such as the memory capacity and remaining memory for installed cards can be displayed on the recorder (P.34).

| Card Info. |       |
|------------|-------|
| ■ SD       |       |
| Remain     | 540MB |
| Capacity   | 1.0GB |
| BACK       | EXIT  |

**Notes**

- When initializing (formatting) a card, confirm that no necessary data is stored on the memory card beforehand. Initialization completely erases the existing data on the card.
- In some cases cards which have been formatted (initialized) by another device, such as a computer, cannot be recognized. Be sure to format them with this recorder before using.
- The card has a service life. When reaching the end of its life, writing or erasing data on the card will be disabled. In this case, replace the card.
- If you use a PC card adapter compatible with the card to save or delete some data on the card, the maximum recording time on the card may be decreased. To recover the original recording time, initialize/format the card in the recorder.
- Olympus will not be held liable for any data corruption or loss due to misuse of the media card.

# Identification of Parts

1

Identification of Parts

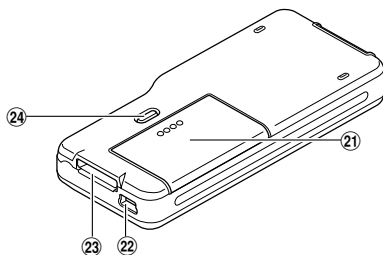
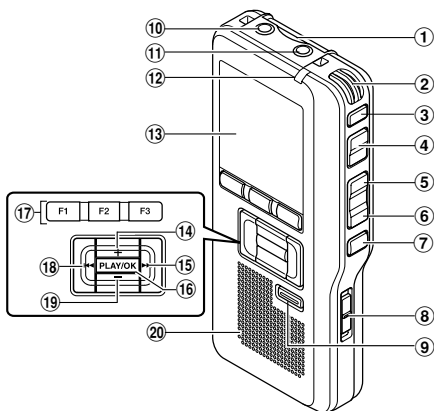

- ① SD card slot
- ② Built-in microphone
- ③ NEW button
- ④ REC button
- ⑤ REW button
- ⑥ FF button
- ⑦ STOP button
- ⑧ POWER/HOLD switch
- ⑨ ERASE button
- ⑩ EAR (Earphone) jack
- ⑪ MIC (Microphone) jack
- ⑫ Record indicator light
- ⑬ Display (LCD panel)
- ⑭ + (Volume) button
- ⑮ Fast Forward (▶▶) button
- ⑯ PLAY/OK button
- ⑰ Programmable smart button (F1, F2, F3)
- ⑱ Rewind (◀◀) button
- ⑲ - (Volume) button
- ⑳ Built-in speaker
- ㉑ Battery cover
- ㉒ PC (USB) terminal
- ㉓ Cradle connector
- ㉔ Battery cover release button

## Display Status Indicators

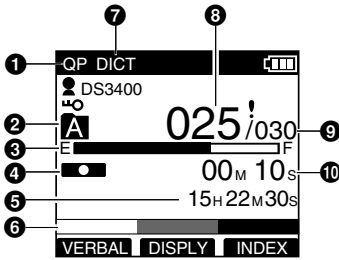

Display in the recording mode

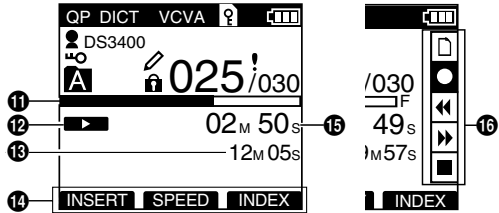

Display in the playback mode

- ① Record mode indicator
- ② Current folder
- ③ Memory remaining indicator (E/F bar)
- ④ Record indicator
- ⑤ Remaining recording time
- ⑥ Level meter indicator
- ⑦ Microphone sensitivity indicator
- ⑧ Current file number
- ⑨ Total number of files in the folder

- ⑩ Recording elapsed time
- ⑪ Playback position bar indicator
- ⑫ Play indicator
- ⑬ Total recording time of the selected file
- ⑭ Button guide display
- ⑮ Current Playback time
- ⑯ Main Button Guide

You can display the Main Button Guide by using “Main Button Guide” (P.58) of the customize functions of DSS Player.

- Ⓐ Author ID indicator
- 🔋 Battery indicator
- VCVA VCVA (Variable Control Voice Actuator) indicator

- ✎ Pending indicator
- 🔒 Card Lock indicator
- 🔒 Encryption indicator
- ⚠ Priority indicator
- 🔒 Erase Lock indicator

# Installing Batteries

This recorder can be used with AAA Alkaline Batteries.

- 1 Lightly press down on the battery cover release button, then open the battery cover.

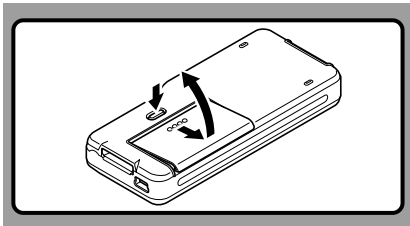

- 2 Insert two AAA batteries, observing the correct polarity as shown in the illustration below, then close the battery cover.

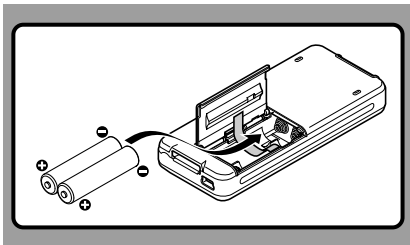



Insert the batteries in the direction inscribed on the inside of the recorder's battery compartment. In addition, when inserting the batteries, insert them so that the tape is under the batteries, as shown in the illustration. The batteries can then be removed easily by pulling up the tape. **When pulling on the tape the batteries may suddenly pop out, so be sure to press down lightly on the batteries with your finger while pulling.**

## Recharging Battery Pack

The battery indicator on the display changes as the batteries lose power.



When  appears on the display, replace the batteries as soon as possible.

When the batteries are too weak, the recorder shuts down and [  Battery Low ] appears on the display.

## Cautions Concerning the Battery

### ⚠ Warning



- Using batteries for which part or all of the external coating (insulating sheath) is peeling off or batteries which have ruptured may cause fluid leaks, overheating, and explosions. For this reason such batteries should absolutely not be used.



- Commercially available batteries for which part or all of the external coating (insulation sheath) has been peeled off should absolutely not be used.

### Unusable batteries

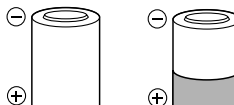

Batteries for which the entire external coating (insulating sheath) is peeled off (naked batteries), or those where it has partially been peeled off.

### Notes

- **Be sure to turn OFF the recorder before replacing the batteries.** Removing the batteries while the recorder is in use may corrupt the card. If you are recording into a file and the batteries run out, you will lose your currently recorded file since the file header will not be written. It is crucial to replace the batteries when one hash mark is shown in the battery icon.
- Be sure to replace both batteries at the same time.
- **Never mix old and new batteries, or batteries of different types and/or brands.**
- If it takes longer than 1 minute to replace dead batteries, you may have to reset the time when you load new batteries.
- Remove the batteries if you are not going to use the recorder for an extended period of time.

## Power Supply

When the recorder is not being used, turn the power off to reduce battery consumption to a minimum. Even if the power is turned off, existing data, mode settings, and clock settings will be maintained.

### Turning On the Power

While the recorder's power is off, slide the **POWER/HOLD** switch in the direction indicated by the arrow.

The display will turn on, and after [System Check] appears, the power will be turned on. The resume function will bring the recorder back to the stop position in memory before power was turned off.

### Turning Off the Power

Slide the **POWER/HOLD** switch in the direction indicated by the arrow for 0.5 seconds or longer.

The display shuts off and the power will be turned off. The resume function remembers the stop position before the power is turned off.

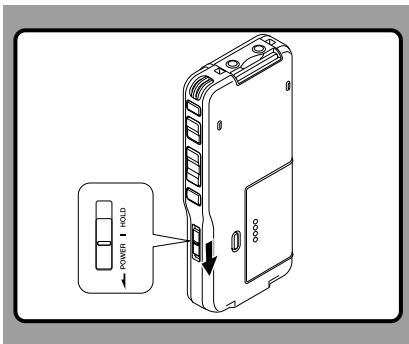

## Power Save Mode (Power Save)

When the recorder is ON but not in use for 10 minutes, by default, it will switch to power save mode automatically. To reactivate the recorder again, operate any button or the slide switch.

### Power Save Setting

You can set the time to enter Power Save mode from among [5 minutes.], [10 minutes.], [30 minutes.], [1 hour], and [Off]. To exit power save, press any button.

The [Power Save] setting can be changed from the Menu. For more details, refer to "Menu List" (P.33) and "Learning to Use the Menu" (P.35).

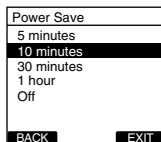

# HOLD

If you bring the POWER/HOLD switch to the HOLD position, the current conditions will be preserved, and all buttons and switches will be disabled. This feature is useful when the recorder has to be carried in a bag or pocket.

## Set the recorder to HOLD mode

Slide the **POWER/HOLD** switch to the **HOLD** position.

After [Hold] appears on the display, the recorder is set to HOLD mode.

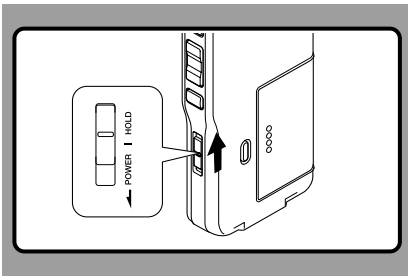

## Exit HOLD mode

Slide the **POWER/HOLD** switch to the **A** position.

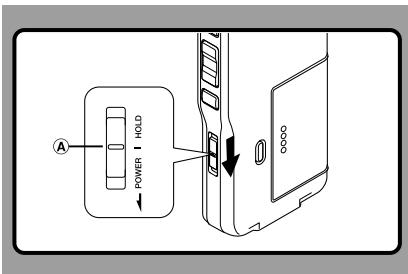

# Inserting and Ejecting a SD card

## Inserting a SD card

Insert the SD card into the card slot in the direction shown in the illustration until it clicks.

When inserting SD card into the SD card slot, the recorder message [Please Wait] will flash on the LCD display for a few seconds while validating the SD card.

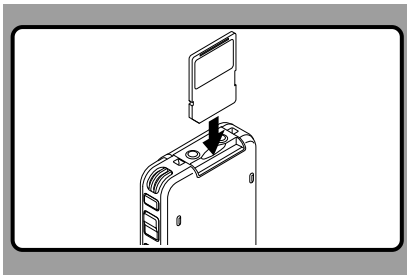

## Ejecting a SD card

Push the SD card inward once to unlock it, and let it eject.

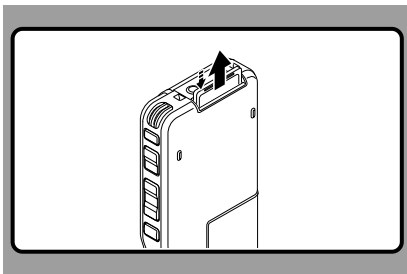

## Notes

- Insert the card keeping it straight.
- The card stops with a click when it is inserted all the way.
- Inserting the card the wrong way or at an angle could damage the contact area or cause the card to jam.
- If the card is not inserted all the way, data may not be written to the card.
- Hold the card straight and pull it out.
- If an unformatted card is installed, the recorder will automatically display the menu format option (≡ P.54).
- Never use any card in the recorder unless it has been formatted on this unit (≡ P.54).
- Never remove the card while the recorder is in operation. This may damage the data.
- Releasing your finger quickly after pushing the card inward may cause it to eject forcefully out of the slot.



# Setting Time and Date (Time & Date)

Setting the correct time and date on the recorder is very important since every file recorded on the recorder will have the time and date information as part of the file header. This will simplify the file management aspects later on.

The hour indicator will flash automatically when you load batteries before using the recorder for the first time, or after the recorder has not been used for a long time. However, when a Password has been set as the device lock function (see P.38), the recorder will go to the time and date set screen after verification (unlocking).

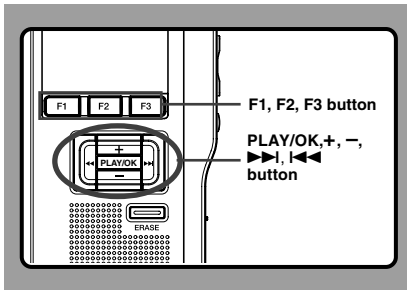

## 1 Press the >>> or <<< button to select the item to set.

Select the item from "hour", "minute", "year", "month" and "day" with a flashing point.

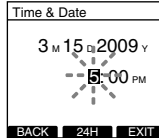

## 2 Press the + or - button to set.

Follow the same steps by pressing the >>> or <<< button to select the next item, and press the + or - button to set.

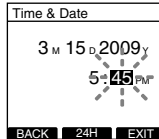

- You can choose between 12 and 24 hour display by pressing the F2(24H or 12H) button while setting the hour and minute.

Example: 5:45 P.M.

5:45 PM (Initial setting) ↔ 17:45

## Setting Time and Date (Time & Date)

- You can choose the order of the year, month, day by pressing the F2(D/M/Y or Y/M/D or M/D/Y)\* button while setting them.  
Example: March 15, 2009

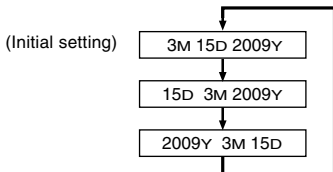

\*The display will vary depending on the status of the settings.

### 3 Press the **PLAY/OK** button to complete the setup screen.

The clock will start from the set date and time. Press the **PLAY/OK** button according to the time signal.

### Notes

- If you press the **STOP** button during the setup operation, the settings are cancelled, and the recorder returns to the previous screen.
- You can set the time and date from your PC using DSS Player software (☞ P.59).

## Changing the Time and Date

When the recorder's **POWER/HOLD** switch is turned ON the [Time & Date] will be displayed for two seconds. If the time and date is not correct, set it using the procedure below.

- 1 Press the **+** or **-** button in the [Device Menu] screen, then select [Time & Date]. See P.34 regarding the menu.

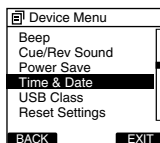

- 2 Press the **PLAY/OK** or **▶▶▶** button.  
The time and date screen appears. The hour indicator flashes, indicating the start of the time and date setup process. The following steps are the same as Step 1 through Step 3 of "Setting Time and Date (Time & Date)" (☞ P.17).
- 3 Press the **F3(EXIT)** or **◀◀◀** button to complete the setting.

# 2 Basic Operations

## Recording

The recorder has five folders, A, B, C, D, E and you can select folder by pressing the F1(FOLDER) button. These five folders can be selectively used to distinguish the kind of recording; for example, Folder A might be used to store private information, while Folder B might be dedicated to holding business information. Up to 200 messages can be recorded per folder.

By default, the Recording Mode is QP.

### Record Function

By default, the RECORD function is configured to record at the current position (overwrite). However, that can be changed to any of the following settings:

- Append: Appends the recording to the end of the current file (☞ P.20).
- Overwrite: Overwrites the recording starting at the current position in the file (☞ P.21).
- Insert: Inserts the recording at the current position in the file (☞ P.22).

### Recording Related Settings

Recording related settings can be configured to provide a suitable recording environment.

- Microphone Sensitivity (Mic Sense) (☞ P.23)
- Recording Modes (Rec Mode) (☞ P.24)
- Using the Variable Control Voice Actuator (VCVA) (☞ P.25)
- Recording Monitor (☞ P.26)
- Verbal Comment (☞ P.46)
- Pending Files (Pending) (☞ P.41)

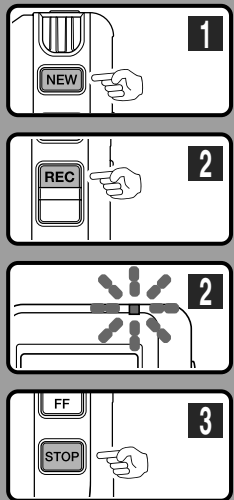

## New Recording

Create a new file to record in.

### 1 Press the **NEW** button to create a new file.

- Ⓐ Selected Author ID
- Ⓑ New file number
- Ⓒ Remaining recording time

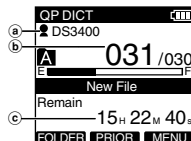

### 2 Press the **REC** button to start recording.

The record indicator light glows orange and (Record indicator) appears on the display.

Aim the microphone at the sound source. When you press the F2 (DISPLY) button during recording, you can change the LCD screen displays.

- Ⓐ Record indicator

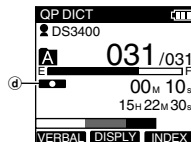

### 3 Press the **STOP** button to stop recording.

If you want to append additional recordings to the same file, press the REC button again.

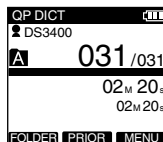

## Notes

- A beep will sound when the remaining recording time reaches 60 seconds, 30 seconds, and 10 seconds while recording.
- When remaining recording time is less than 60 seconds, the record indicator light starts flashing in orange. When the recording time is decreasing to 30 or 10 seconds, the light flashes faster.
- [Memory Full] or [Folder Full] will be displayed when the memory or folder capacity is full.
  - Delete any unnecessary files before recording any further (Ⓝ P.29) or transfer dictation files to your computer using DSS Player Software (Ⓝ P.59).

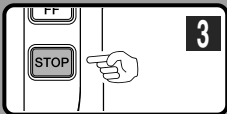
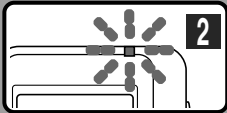
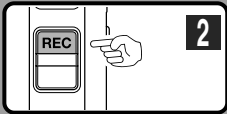

## Overwrite Recording

You can overwrite a previously recorded file from any point within the file.

Note that the overwritten recordings will be erased.

### 1 Select and play the file you want to overwrite.

Stop playback at the starting point of overwrite.

### 2 Press the **REC** button to start overwriting.

The record indicator light glows orange and  (Record indicator) appears on the display.

- Ⓐ Recording elapsed time
- Ⓑ Total recording time of the selected file

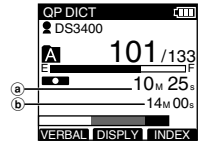

### 3 Press the **STOP** button to stop overwriting.

#### Note

- You cannot select a different recording mode (QP, SP) than that of the original file before overwrite recording.

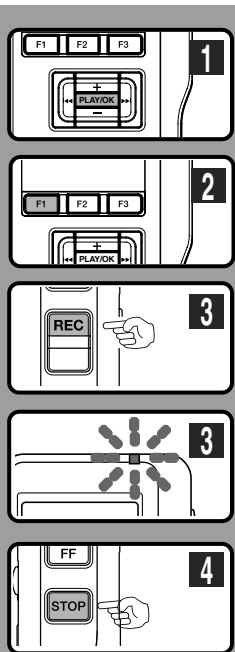

## Insert Recording

Additional recording can be inserted into previously recorded file.

- 1 Select and play the file you want to insert an additional recording into.
- 2 While playing the file, press the **F1 (INSERT)** button to insert an additional recording.  
[Insert Rec?] appears on the display.
- 3 Press the **REC** button to start inserting an additional recording.  
The record indicator light glows orange and  (Record indicator) appears on the display.  
[Insert Rec] and the remaining recording time will alternate on the display.
- 4 Press the **STOP** button to stop inserting the additional recording.

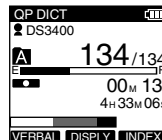
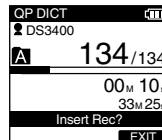

## Notes

- The recording time and date of the file is updated to the time and date of the inserted recording.
- You cannot select a different recording mode (QP, SP) than that of the original file before inserting.

# Microphone Sensitivity (Mic Sense)

You can switch between two microphone sensitivities to meet recording needs: [Dictation] for oral dictation and [Conference] which is suited for situations like meetings and conferences with a small number of people. The setting status will appear on the display as **CONF** or **DICT**.

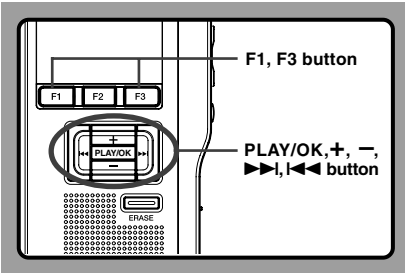

- 1 Select **[Mic Sense]** at the **[Record Menu]** screen, then press the **PLAY/OK** or **>>>** button.

Refer to P.33 regarding each menu item settings.

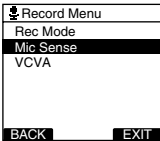

- 2 Press the **+** or **-** button to select **[Conference]** or **[Dictation]**.

**Conference...**High-sensitivity mode that records sounds in all directions.

**Dictation...**Low-sensitivity mode suited for dictation.

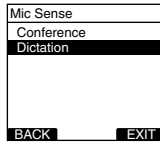

- 3 Press the **PLAY/OK** button to complete the setup screen.

[Conference Set] or [Dictation Set] will light up on the display, and it will return to the [Record Menu] screen.

If you press the **<<<<** or **F1(BACK)** button the setting will be cancelled and it will return to the [Record Menu].

Pressing the **F3(EXIT)** button will cancel the contents being set and take you out of the MENU.

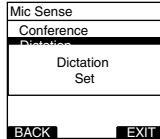

- 4 Press the **F3(EXIT)** or **<<<<** button to complete the setting.



# Recording Modes (Rec Mode)

The recording mode can choose between QP (Quality Playback) and SP (Standard Playback).

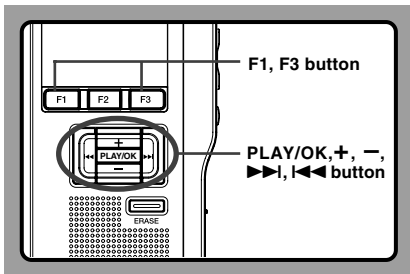

1 Select [Rec Mode] at the [Record Menu] screen, then press the **PLAY/OK** or **>>>** button.

Refer to P.33 regarding each menu item settings.

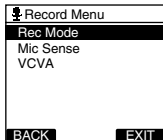

2 Press the **+** or **-** button to select [QP] or [SP].

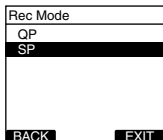

3 Press the **PLAY/OK** button to complete the setup screen.

[QP Set] or [SP Set] will light up on the display, and it will return to the [Record Menu] screen.

If you press the **<<<** or F1 (BACK) button the setting will be cancelled and it will return to the [Record Menu].

Pressing the F3 (EXIT) button will cancel the contents being set and take you out of the MENU.

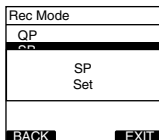

4 Press the **F3 (EXIT)** or **<<<** button to complete the setting.

Set Recording Mode is displayed when creating the New File and during recording.

The recording mode of file recording is displayed during playback and in stop mode.



## Note

- Choose QP mode for recording meetings or lectures with crisp clarity.
- You cannot select the QP mode when setting the recorder to the DSS Classic mode. For details, see "Recording" in the "Customizing the Recorder" (P.58).



# Using the Variable Control Voice Actuator (VCVA)

The Variable Control Voice Actuator (VCVA) is a function that starts recording automatically when the microphone senses that sounds have reached a preset threshold volume level, and automatically pauses when the volume drops below the threshold. The VCVA feature allows you to conserve memory by automatically stopping recording in instances like long silent periods during meetings.

When this is enabled, **VCVA** will appear on the display.

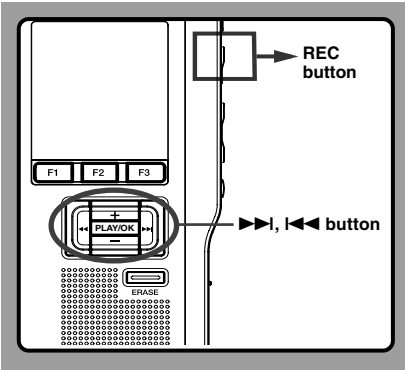

- 1 **Set the VCVA in the menu to [On].**  
Refer to P.33 regarding each menu item settings.

- 2 **Press the REC button to start recording.**  
When the sound volume is lower than the preset actuation sound level, recording automatically stops after 1 second approximately, and "Stand by" flashes on the display. The record indicator light glows orange and  (Record indicator) appears when recording starts and flashes when recording pauses.

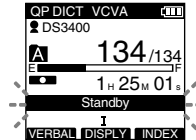

## Adjust the Start/Stop Actuation Level

While the recorder is in recording mode, press the **>>>|** or **<<<** button to adjust the actuation level.

The VCVA level can be set to any of 15 different values. The higher the value is, the more sensitive the recorder can react to sounds. At the highest value, even the faintest sound will activate recording. The VCVA actuation level can be adjusted according to the ambient (background) noise.

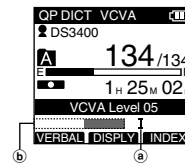

- a **Start level**  
(Varies according to the sound volume being recorded)
- b **Level meter indicator** (moves to the left/right according to the set level)

## Notes

- The start/stop actuation level also varies depending on the selected microphone sensitivity mode (≠P.23).
- To ensure successful recordings, prior testing and adjustment of the start/stop actuation level is recommended.
- If the recorder detects an input that exceeds the Start level, the dotted line of the Level meter indicator will change to the full line, and the recorder starts recording.

# Recording Monitor

---

It is possible to monitor your recording by listening to the recording while recording is in progress. Insert the earphone plug into the earphone jack and use the + or – button to control the volume level.

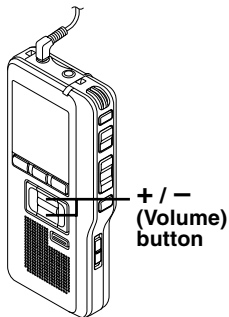

## 2 Recording Monitor

---

### Note

- Insert the plugs in to the end as shown in the illustration when inserting the earphone or external microphone.

# Playing

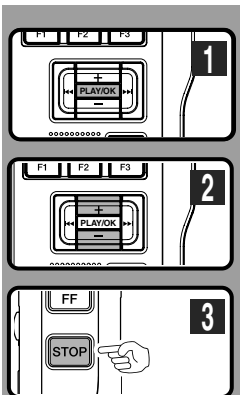

You can start playing a file at any point.

## 1 Select the file, then press the **PLAY/OK** button to start playback.

The  (Play indicator) appears on the display.

Ⓐ Play indicator

## 2 Press the **+** or **-** button to adjust the volume.

The display shows the volume level. You can choose between 00 to 30.

Ⓑ Volume level

## 3 Press the **STOP** button at any point you want to stop the playback.

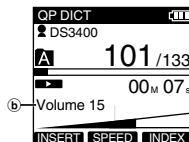
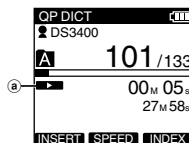

| Playback functions       | Operation  | How to Cancel                                   |
|--------------------------|--|---|
| <b>Fast Forward (FF)</b> | Press the <b>▶▶</b> or <b>FF</b> button once while stopped.  | Press the <b>PLAY/OK</b> or <b>STOP</b> button. |
| <b>Rewind (REW)</b>      | Press the <b>◀◀</b> or <b>REW</b> button once while stopped.   | Press the <b>PLAY/OK</b> or <b>STOP</b> button. |
| <b>Cue (CUE)</b>         | Press and Hold the <b>▶▶</b> or <b>FF</b> button while stopped or playing a file.  | Release the button.                             |
| <b>Review (REV)</b>      | Press and Hold the <b>◀◀</b> or <b>REW</b> button while stopped or playing a file.   | Release the button.                             |
| <b>Playback Speed</b>    | <p>Press the <b>F2 (SPEED)</b> button during playback.</p> <p>↪ Every time the <b>F2(SPEED)</b> button is pressed, the playback speed will switch.</p> <p><b>Play(playback):</b> Playback at normal speed.</p> <p><b>Slow Play (slow playback):</b> Playback speed slows down (-50%), and “Slow play” will turn on.</p> <p><b>Fast Play (fast playback):</b> Playback speed becomes faster (+50%), and “Fast play” will turn on.</p> | _____   |

## Notes

- If you press the **▶▶** or **FF** button once while fast-forwarding or twice while stopped, the recorder will stop at the end of the file (F.Skip).
- If you press the **◀◀** or **REW** button once while rewinding or twice while stopped, the recorder will stop at the beginning of the file (B.Skip). If the **◀◀** or **REW** button is pressed within 2 seconds, the recorder skips to the beginning of the previous file.

# Erasing

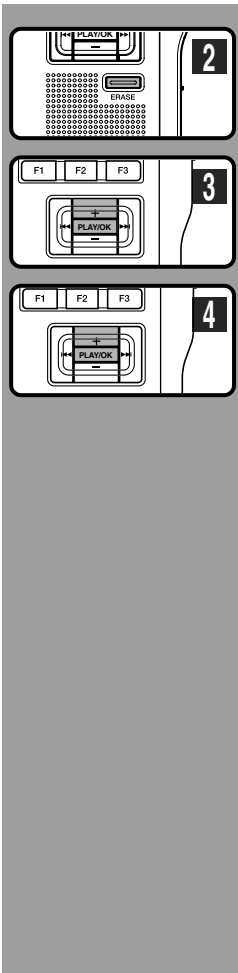

## Erasing a File

Erasing or deleting a file from any of the folder on the recorder is a very simple process.

- 1 Select the file you want to erase.
- 2 Press the **ERASE** button.
- 3 Press the **+** button to select [File Erase], then press the **PLAY/OK** button.
- 4 Press the **+** button to select [Start], then press the **PLAY/OK** button.  
The display changes to [File Erase !] and erasing will start.

[Erase Done] is displayed when the file is erased. File numbers will be reassigned automatically.

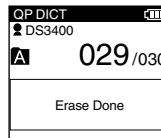
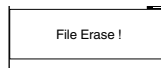
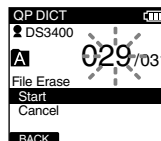
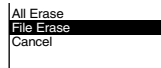
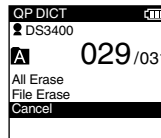

### Notes

- An erased file cannot be restored.
- Files cannot be erased in the following cases.
  - File being set [Lock] (☞ P.40).
  - The SD card lock is turned on (☞ P.8).

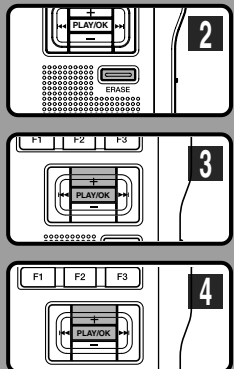

## Erasing All Files in a Folder

All files in a folder can be erased simultaneously.

- 1 Select the folder you want to erase.
- 2 Press the **ERASE** button.
- 3 Press the **+** button to select [All Erase], then press the **PLAY/OK** button.
- 4 Press the **+** button to select [Start], then press the **PLAY/OK** button.  
The display changes to [All Erase !] and erasing will start.

[Erase Done] is displayed when the files are erased. Any locked files in the folder will be reassigned new file numbers in ascending order.

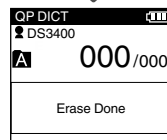
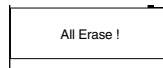
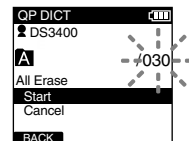
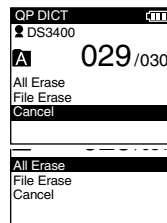

### Notes

- The erasing process may take up to 10 seconds. Do not interrupt this process! Data will be destroyed.
- Files cannot be erased in the following cases.
  - File being set [Lock] (☞ P.40).
  - The SD card lock is turned on (☞ P.8).

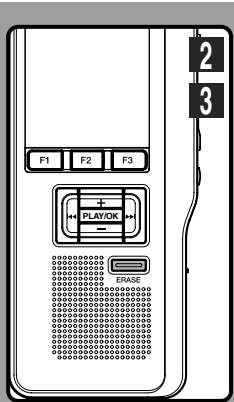

## Partially Erasing a File

You can erase a selected file in part.

- 1 **Start playback for the file you want to erase partially.**  
While playback continues, [Partial Erase] will appear on the display.
- 2 **Press the **ERASE** button at the point to start erasing.**

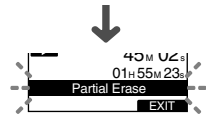
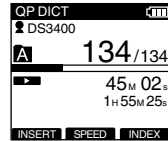

- 3 **Press the **ERASE** button at the point to end erasing.**

The erase starting point (time) set in step 2 and the ending point (time) set in this step will alternate on the display for 8 seconds.  
If you playback to the end of file or to the start position of the Verbal comment (see P.46), that will mark the end position for the partial erase automatically.

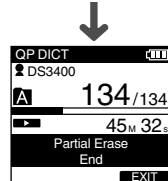

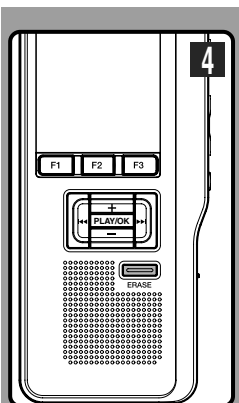

#### 4 Press the **ERASE** button to confirm erase.

The display changes to [Partial Erase!] and erasing will start.

When [Erase Done] appears on the display, partial erase is complete.

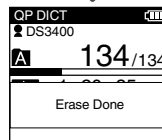
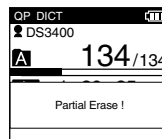

#### Notes



- If the ERASE button is not pressed within 8 seconds after the “Partial Erase Start” and “Partial Erase End” are alternately displayed, the recorder will revert to stop status.
- An erased file cannot be restored.
- Files cannot be Partial erased in the following cases.
  - File being set [Lock] (☞ P.40).
  - Files that Verbal comment is being played back (☞ P.46).
  - The SD card lock is turned on (☞ P.8).



# 3 Advanced Operations

## Menu List

- Menu Setting (while the recorder is stopped, press the **F3(MENU)** button)

| Main Menu   | Second layer | Setting  | Ref. Page |
|---|--------------|--|-----------|
| <br>File Menu    | Priority     | Cancel, Set  | P.42      |
|   | Pending      | Finished, Pending                                      | P.41      |
|   | Lock         | Off, On  | P.40      |
|   | Work Type    | Edit the Work Type and Option Item.                    | P.43      |
|   | Information  | The file information is displayed.                     | P.37      |
| <br>Record Menu  | Rec Mode     | QP, SP   | P.24      |
|   | Mic Sense    | Dictation, Conference                                  | P.23      |
|   | VCVA         | Off, On  | P.25      |
| <br>Display Menu | Backlight    | On, Off  | P.49      |
|   | Contrast     | Program contrast level 01~12 (Default is 6).           | P.51      |
|   | LED          | On, Off  | P.50      |
|   | Language     | English, Deutsch, Français, Español, Italiano, Русский | P.48      |
| Device Menu<br>(To the next page)   |              |  |           |

| Main Menu  | Second layer   | Setting  | Ref. Page |
|--|----------------|--|-----------|
| <br>Device Menu | Beep           | <b>On</b> , Off  | P.52      |
|  | Cue/Rev Sound  | <b>On</b> , Off  | P.53      |
|  | Power Save     | In order of 5 minutes, <b>10 minutes</b> , 30 minutes, 1 hour and Off. | P.14      |
|  | Time & Date    | In order of hour, minute, year, month and day.                         | P.17      |
|  | USB Class      | <b>Composite</b> , Storage   | P.57      |
|  | Reset Settings | Returns the menu settings to their initial state.                      | P.55      |
|  | Format         | Initializes the card.  | P.54      |
|  | Card Info.     | Remain, Capacity   | P.9       |
|  | System Info.   | Model Name, Version, Serial  | P.56      |
| File Menu<br>(To the page 33)  |                |  |           |

### Notes

- The selectable language varies depending on the countries where the product was purchased.
- Items appear in bold letters in the "Setting" column to indicate that they are the initial settings.

# Learning to Use the Menu

To navigate through the different options in the Menu, use the Menu List flow chart (P.33, 34) and the following steps to modify or change any settings.

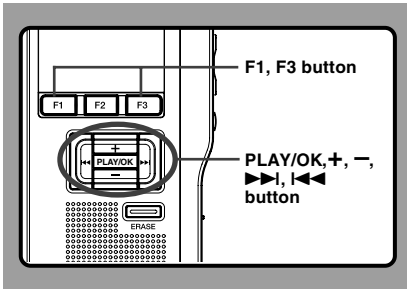

- 1 Press the F3(MENU) button.**  
The [Main Menu] screen will appear on the display (P.33).

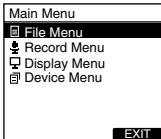

- 2 Press the + or - button to move to [Main Menu] item to be set.**

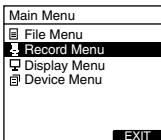

- 3 Press the PLAY/OK or >>> button.**  
Move to the setting of the selected menu items.

- 4 Press the + or - button to move to the menu item to be set.**

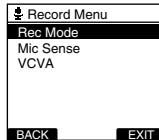

- 5 Press the PLAY/OK or >>> button.**  
Move to the setting of the selected item.

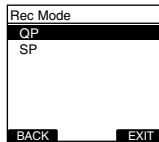

- 6 Press the + or - button to change the setting.**

- 7 Press the PLAY/OK button to complete the setup screen.**

If you press the <<< or F1(BACK) button, the setting will be cancelled and it will return to the menu.

Pressing the F3(EXIT) button will cancel the contents being set and take you out of the MENU.

- 8 Press the F3(EXIT) or <<< button to complete the setting.**

# Selecting Folders and Files

3

Selecting Folders and Files

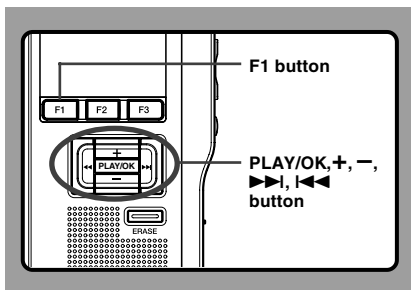

## Changing Folders

- 1 While the recorder is stopped, press the **F1(FOLDER)** button.

The folder list screen will be displayed.

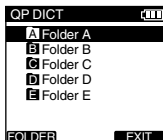

- 2 Press the **+** or **-** button to select the folder, then press the **PLAY/OK** button.

This will change the folder.

You can switch folders by pressing the F1(FOLDER) button.

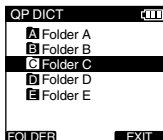

## Changing File

- 1 While the file is being displayed, press the **>>>** or **<<<** button.

This will change and display the file number order for files within the folder.



- a Current file number
- b Total number of recorded files in the folder

## Scroll bar

The scroll bar will appear when all of the items cannot be displayed in the menu or list display screen.

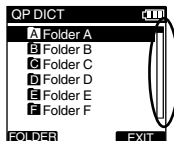

# Displaying File Information (Information)

The recorder can display a variety of information related to the current file.

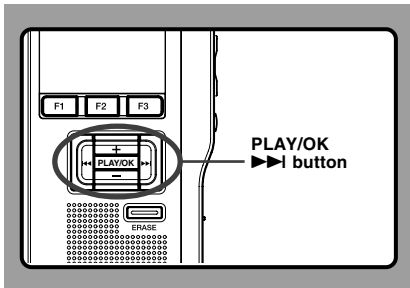

## 1 Select the file whose information you want to display.

Refer to P.36 regarding file selection.

## 2 Select [Information] at the [File Menu] screen, then press the **PLAY/OK** or **▶▶▶** button.

The file information is displayed.

Refer to P.33 regarding each menu item settings.

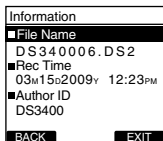
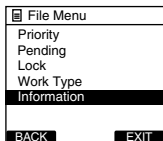

## The Displayed Information

The following information will be displayed.

**[File Name]**...File name

**[Rec Time]**...Time and date the file was recorded.

**[Author ID]**...Display the Author ID of file.

**[Work Type]**...Display the Work Type ID of file.

**[Option Item]**...Display the Option Item which has been set.

## Note

- When the file that Work Type or the Option Item is set is transferred from PC to this unit, the information will be displayed on the File Information.

# Device Lock Function

3

Device Lock Function

Recorder access can be restricted by enabling the device lock function. Authentication via password can act as a safe guard for your data even in case the recorder is lost or left unattended.

Password registry can be performed by using DSS Player (P.59).

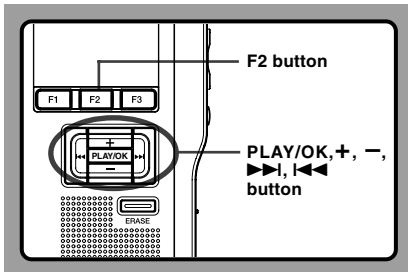

## Unlocking the Recorder

When the password registry is done, the recorder will prompt for password on startup.

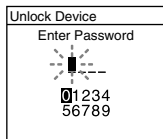

Unlock the recorder's device lock through the method below.

The default password when using the recorder for the first time is "0000".

## Unlocking the Recorder with a Password

- 1 Select the numbers you want to enter by pressing the +, -, >>> or <<< button to move the cursor.

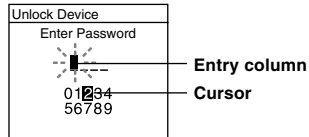

- 2 Press the **PLAY/OK** button to select a number.

A \* will appear in the selected first digit and the blinking cursor will move to the next one over (to the right). Repeat steps 1 and 2 to enter all four digits.

Pressing the ERASE button at any time will erase the last entry and move the cursor to the previous entry (to the left).

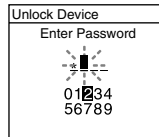

- 3 After all four digits have been entered, press the **F2(ENTER)** button.

If the 4 digit number entered matches the registered password then the startup message will appear and the recorder will start up.



### Authentication Halt Mode

If there is no password match after five tries the recorder will enter password input halt mode for ten minutes.

After ten minutes have passed the mismatch history will be erased and it will once again return to the password input screen.

|                     |
|---------------------|
| Unlock Device       |
| Enter Password      |
| Device is<br>Locked |
| 09 : 59             |
|                     |

# Locking Files (Lock)

When a file is set to [Lock],  will appear on the display, allowing you to prevent important files from accidental erase. Furthermore, the file will not be erased even when all files within a folder are erased.

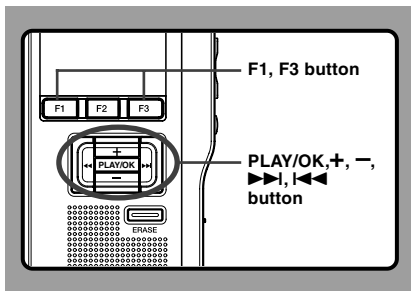

- 1 Select the file you want to Lock.
- 2 Select [Lock] at the [File Menu] screen, then press the **PLAY/OK** or **>>>** button.

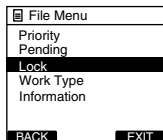

- 3 Press the **+** or **-** button to select [On] or [Off].

**On**...Locks the file and prevents it from being erased.

 appears on the display.

**Off**...Unlocks the file and allows it to be erased.

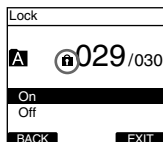

- 4 Press the **PLAY/OK** button to complete the setup screen.

[File Lock On] or [File Lock Off] will light up on the display, and it will return to the [File Menu] screen.

If you press the **<<<** or **F1 (BACK)** button the setting will be cancelled and it will return to the [File Menu].

Pressing the **F3 (EXIT)** button will cancel the contents being set and take you out of the MENU.

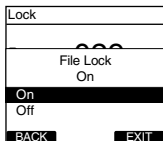

- 5 Press the **F3 (EXIT)** or **<<<** button to complete the setting.

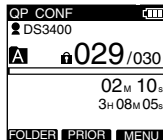



# Pending Files (Pending)

When you set [Pending] to the file, the file becomes “Pending file” and the editing sign of ✎ will appear on the display. If “Download file” is set to “Finished file” by DSS Player, the [Pending] file is not transferred and only [Finished] file (edited file) will be transferred to your PC.

For details, see “Recording” in the “Customizing the Recorder” (☞ P.58).

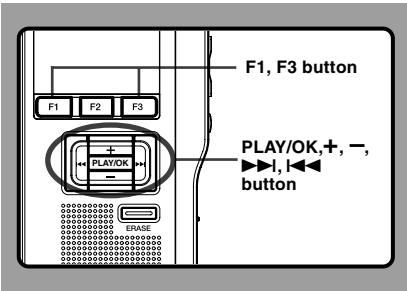

- 1 Select [Pending] at the [File Menu] screen, then press the **PLAY/OK** or **>>>** button. Refer to P.33 regarding each menu item settings.

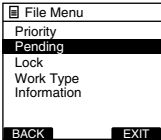

- 2 Press the **+** or **-** button to select [Pending] or [Finished].

**Pending...** Sets to a file of “Editing” and ✎ appears on the display.

**Finished...** Sets to a file of “already edited”.

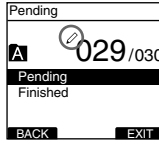

- 3 Press the **PLAY/OK** button to complete the setup screen.

[Pending Set] or [Finished Set] will light up on the display, and it will return to the [File Menu] screen.

If you press the **<<<** or **F1(BACK)** button the setting will be cancelled and it will return to the [File Menu]. Pressing the **F3(EXIT)** button will cancel the contents being set and take you out of the MENU.

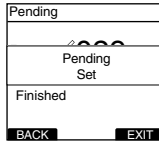

- 4 Press the **F3(EXIT)** or **<<<** button to complete the setting.

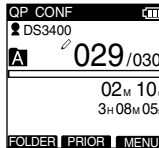

# Setting Priority Levels (Priority)

By default, F2 button is programmed with Priority function. The setting can also be performed from the menu.

You can set a priority level on each file recorded. You can choose between "HIGH" and "NORMAL". The default is Normal level.

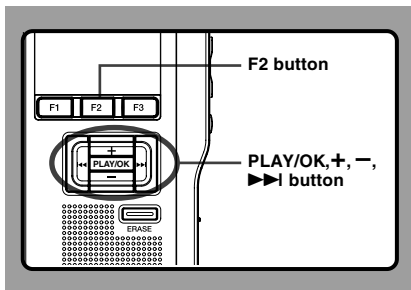

## To Set a Priority Level on a File

### To Set the F2(PRIOR) Button

- 1 Select the file you want to perform the setting on, then press the **F2(PRIOR)** button.

Each time the F2(PRIOR) button is pressed the Priority level will change (HIGH/NORMAL). When the HIGH level setting is selected, **!** will appear on the display.

Perform the setting in the same manner after creating a New file.



a Priority indicator

### Performing the Setting from the Menu

- 1 Select the file which you would like to set the Priority level for.
- 2 Select [Priority] at the [File Menu] screen, then press the **PLAY/OK** or **>>>** button.

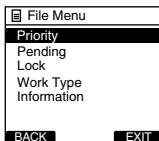

- 3 Press the **+** or **-** button to select [Set] or [Cancel], then press the **PLAY/OK** button.

[Set]...High Level.  
[Cancel]...Normal Level.

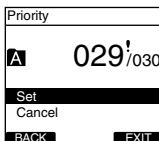

# Setting the Author ID and Work Type

Every file recorded on the recorder will include the Author ID and Work Type as part of its header information. To create multiple Author IDs and Work Types on the recorder, use the bundled DSS Player software to create and upload a Data list (list of Author IDs and Work Types) to the recorder. For more details, refer to the Online help for DSS Player (P.63). By default the Author ID is set to "DS3400".

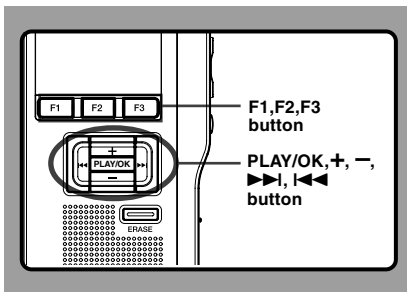

## Setting an Author ID

- 1 Turn ON the recorder.**  
When [Prompt for author ID at Power-on.] has been set through DSS Player (P.59), the registered Author ID List will appear.
- 2 Press the + or - button to select the Author ID that you want to assign to the recorder from the ID list.**

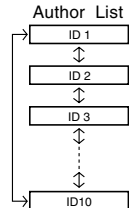
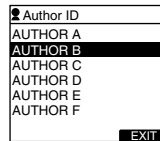

- 3 Press the PLAY/OK button to set the ID.**  
When more than one Author ID exist on the recorder, the ID list will be displayed.

### Note

- Up to 10 Author ID entries can be registered (up to a maximum of 16 characters).

## Setting the Work Type

Up to 10 Work Types can be registered in the DSS Player software and uploaded to the recorder. Each Work Type can have up to 10 Option Items associated with it. The Work Types and Option Items can be used on the recorder to populate the recording file header information. Refer to the Online Help for DSS Player (P.63) regarding registration/set up details and Option Item through DSS Player.

### 1 While the recorder is stopping mode, press the NEW button.

When [Prompt for Worktype ID on new recordings.] has been set through DSS Player (P.59), the Work Types uploaded to the recorder will appear in a list.

### 2 Press the + or - button to select a Work Type from the Work Type list.

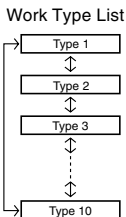
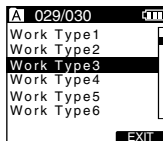

### 3 Press the PLAY/OK button to select the Work Type.

The selected Work Type and a maximum of 10 Option Items registered for that Work Type will be recorded in the New File header information. When the item of Option Item Label within the selected Work Type is possible to set for Value input, it will take you to the file information input screen (P.45). For more details, refer to the Online help for DSS Player (P.63).

## Editing the Work Type

The Work Type information of the recorded or uploaded files can be edited with the menu settings of the recorder (P.33)

### 1 Select the file you want to edit its Work Type information (P.36).

### 2 Select [Work Type] at the [File Menu] screen, then press the PLAY/OK or ►► button.

The Work Type setting screen will appear.

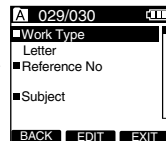
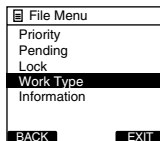

### 3 Press the F2(EDIT) button.

The modification method confirmation screen will appear.

### 4 Press the + or - button to select [Edit Work Type] or [Select From Work Type List], then press the PLAY/OK button.

**Edit Work Type...**This will take you to the file information input screen (P.45) and allow you to modify the Work Type information that has been recorded for the file.

**Select from Work Type List...** You can re-select Work Type from the Work Type list.

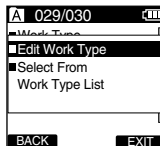

### Inputting Option Item Value

- Press the **+** or **-** button on the file information input screen to select the targeting Option Item, then press the **PLAY/OK** button.

The input screen will be displayed.

When inputting an Option Item value into a New file or the file with a re-selected Work Type, only eligible input characters as specified in the DSS Player can be entered.

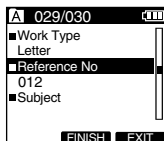

File information input screen

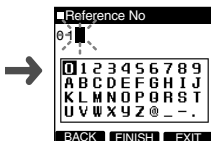

Option item value input screen

- Entering characters.  
Enter characters through the following method.

#### ● Character selection

**+, -, |◀◀, ▶▶| button...** Select the character string (numbers, alphabets or symbols) displayed in the Keyboard window to move the cursor up, down, left and right by pressing.

#### ● Character confirmation

**PLAY/OK button...** Use this button to confirm your selection.

#### ● Moving the entry column

When pressing the **+** button if the cursor is on top of the Keyboard window, the cursor will disappear. An Entry column within the input value display area will change from flashing to lighting. The Entry column can be moved when it is lit.

**▶▶| button...** Each press of the button moves the Entry column one space to the next (right). The Entry column can be moved up to the space next (right) to the last character.

**|◀◀ button...** Each press of the button moves the Entry column one space to the previous (left). The Entry column can be moved up to the first character.

**- button...**The Entry column changes from lighting to flashing. The cursor is lit on the "0" string within the keyboard Window, and makes character selection available.

Entry is performed by insert entry. When the character in the Entry column has already been finalized, the character after the cursor will move one column to the right.

#### ● Maximum entered character count

The Option item value can be entered up to the number of characters specified below. Preset default values can also be set for the option items to simplify data entry process.

**Option Item Value...** 20 characters

#### ● Cancelling the entered contents

Press the **F1(BACK)** button to select [Yes], then press the **PLAY/OK** button during entry... This will erase the entered contents for this item and return you to the File information input screen.

Press the **F3(EXIT)** button to select [Yes], then press the **PLAY/OK** button during entry... This will erase all of the finalized contents for the items, and the recorder will return to stopped state in the New file or the state before entering Menu settings.

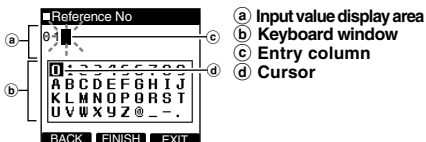

- Press the **F2(FINISH)** button.

The recorder will return to the File information input screen.

When you create a New File and input a Work Type, press the **F2 (FINISH)** button again in the File information screen to get entered into the stop state in the New File.

# Verbal Comment

3

Verbal Comment

The data recorded with the F1(VERBAL) button being pressed during recording, is recorded as a Verbal comment position (a position within a file) in the header.

It is possible to instantly search and play back Verbal comment sections through DSS Player, thereby making it useful for things like giving instructions to transcriptionists.

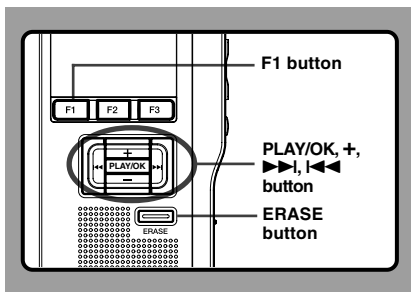

## Setting a Verbal Comment

1 While the recorder is recording mode, press and hold the **F1(VERBAL)** button, then release it when you want to stop.

Audio recorded while continuing to hold the F1(VERBAL) button will be recorded as Verbal Comment.

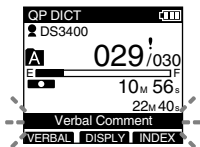

## Locating a Verbal Comment

2 While playing back a file, press and hold the **>>>|<<<** button.

The recorder stops for 1 second when it reaches the Verbal Comment.

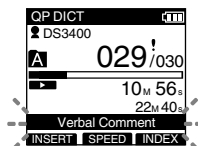

## Clearing an Verbal Comment

3 While playing a Verbal Comment, press the **ERASE** button.

4 Press the **+** button to select [Clear], then press the **PLAY/OK** button.

The Verbal Comment is erased.

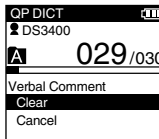

## Notes

- Up to 32 Verbal Comment can be set in a file.
- When a file is locked or set to read-only, or when the SD card lock is enabled Verbal Comment cannot be erased. Clear the settings before erasing.
- When the recorder has been set to DSS Classic mode Verbal comments cannot be recorded. For details, see "Recording" in the "Customizing the Recorder" (P.58).

# Index Marks

Index marks can be placed in a file during recording or playback. Index marks are used to provide a quick and easy way to identify important or significant parts within the file.

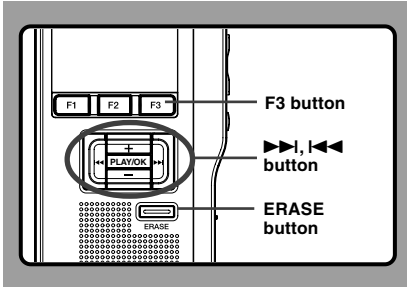

## Setting an Index Mark

- 1 While the recorder is recording or in playback mode, press the **F3 (INDEX)** button to set an Index mark.

An index number appears on the display.

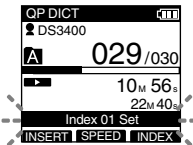

## Locating an Index Mark

- 2 While playing back a file, press and hold the **▶▶|** or **|◀◀** button.

The recorder stops for 1 second when it reaches the Index mark.

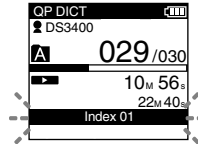

## Clearing an Index Mark

- 3 Locate the Index mark you want to clear.

- 4 While the index number appears for approximately 2 seconds on the display, press the **ERASE** button.

The Index mark is erased.

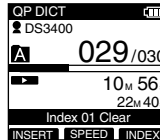

## Notes

- Up to 32 Index marks can be set in a file.
- When a file is locked or set to read-only, or when the SD card lock is enabled Index mark cannot be erased. Clear the settings before erasing.

# Language (Language)

You can select the display language for this recorder.

The selectable language varies depending on the countries where the product was purchased.

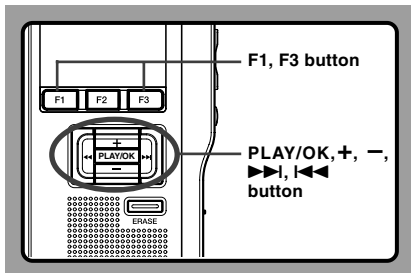

- 1 Select [Language] at the [Display Menu] screen, then press the **PLAY/OK** or **>>>** button.

Refer to P.33 regarding each menu item settings.

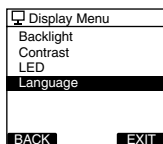

- 2 Press the **+** or **-** button to set the language.

**English...**Displays in English.  
**Deutsch...**Displays in German.  
**Français...**Displays in French.  
**Español...**Displays in Spanish.  
**Italiano...**Displays in Italian.  
**Русском...**Displays in Russian.

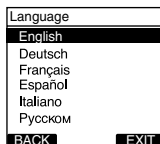

- 3 Press the **PLAY/OK** button to complete the setup screen.

The displayed language is changed and will return to the [Display Menu] screen.

If you press the **<<<** or F1 (BACK) button the setting will be cancelled and it will return to the [Display Menu].

Pressing the F3 (EXIT) button will cancel the contents being set and take you out of the MENU.

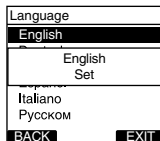

- 4 Press the **F3 (EXIT)** or **<<<** button to complete the setting.

## Note

- The selectable language varies depending on the countries where the product was purchased.



# Backlight (Backlight)

When the display backlight is set to [On], the backlight will light up for about 10 seconds when a button is pressed.

This is useful in that it allows you to check the display even in dark locations.

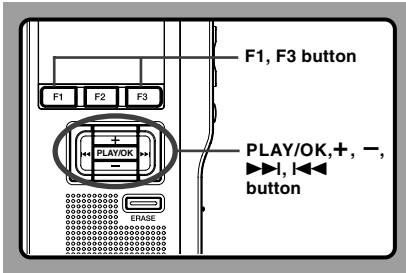

- 1 Select [Backlight] at the [Display Menu] screen, then press the **PLAY/OK** or **>>>** button.

Refer to P.33 regarding each menu item settings.

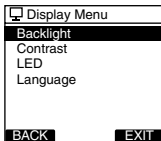

- 2 Press the **+** or **-** button to select [On] or [Off].

**On...**Backlight is enabled.  
**Off...**Backlight is disabled.

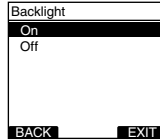

- 3 Press the **PLAY/OK** button to complete the setup screen.

[On Set] or [Off Set] will light up on the display, and it will return to the [Display Menu] screen.

If you press the **<<<** or **F1(BACK)** button the setting will be cancelled and it will return to the [Display Menu].

Pressing the **F3(EXIT)** button will cancel the contents being set and take you out of the MENU.

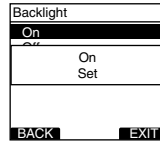

- 4 Press the **F3(EXIT)** or **<<<** button to complete the setting.

# LED (LED)

You can set it so the Record indicator light does not turn on.

## 3 LED

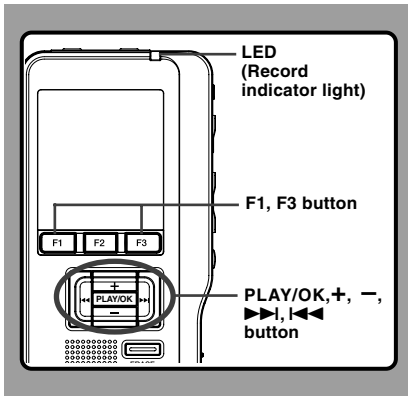

- 1 Select [LED] at the [Display Menu] screen, then press the **PLAY/OK** or **>>>1** button.

Refer to P.33 regarding each menu item settings.

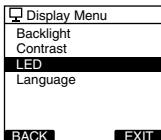

- 2 Press the **+** or **-** button to select [On] or [Off].

**On**...LED light will be set.

**Off**...LED light will be cancelled.

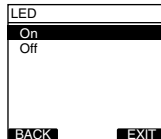

- 3 Press the **PLAY/OK** button to complete the setup screen.

[On Set] or [Off Set] will light up on the display, and it will return to the [Display Menu] screen.

If you press the **1<<<** or **F1(BACK)**, the setting will be cancelled and it will return to the [Display Menu]. Pressing the **F3(EXIT)** button will cancel the contents being set and take you out of the MENU.

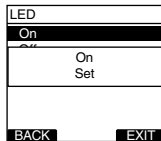

- 4 Press the **F3(EXIT)** or **1<<<** button to complete the setting.

# LCD Contrast Adjustment (Contrast)

Display contrast can be adjusted from level 01 to 12.

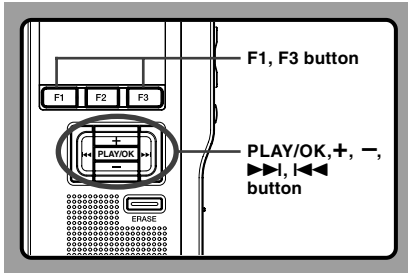

- 1 Select [Contrast] at the [Display Menu] screen, then press the **PLAY/OK** or **>>><** button.

Refer to P.33 regarding each menu item settings.

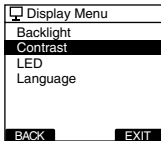

- 2 Press the **+** or **-** button to set the contrast level.

You can adjust the LCD display contrast level from 01 to 12.

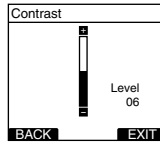

- 3 Press the **PLAY/OK** button to complete the setup screen.

The set contrast level lights up and will return to the [Display Menu] screen.

If you press the **<<<** or F1(BACK), the setting will be cancelled and it will return to the [Display Menu]. Pressing the F3(EXIT) button will cancel the contents being set and take you out of the MENU.

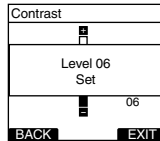

- 4 Press the **F3(EXIT)** or **<<<** button to complete the setting.

# System Sounds (Beep)

When this is set to [On], the recorder beeps to alert you to button operations or warn you of errors.

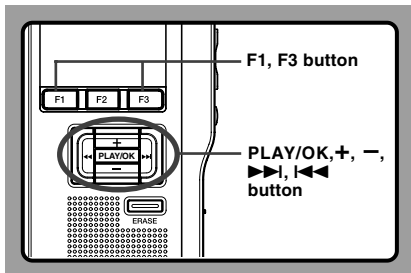

- 1 Select **[Beep]** at the **[Device Menu]** screen, then press the **PLAY/OK** or **>>>** button.

Refer to P.34 regarding each menu item settings.

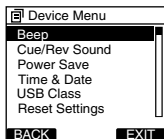

- 2 Press the **+** or **-** button to select **[On]** or **[Off]**.

**On...**System sounds are enabled.  
**Off...**System sounds are disabled.

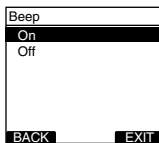

- 3 Press the **PLAY/OK** button to complete the setup screen.

[On Set] or [Off Set] will light up on the display, and it will return to the [Device Menu] screen.

If you press the **<<<** or **F1 (BACK)** button the setting will be cancelled and it will return to the [Device Menu]. Pressing the **F3 (EXIT)** button will cancel the contents being set and take you out of the MENU.

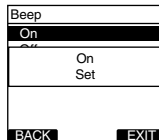

- 4 Press the **F3 (EXIT)** or **<<<** button to complete the setting.

# Cue/Rev Sound (Cue/Rev Sound)

The playback tone of Cue (Cue) operation and Review (Rev) operation can be set to On or Off (P.28).

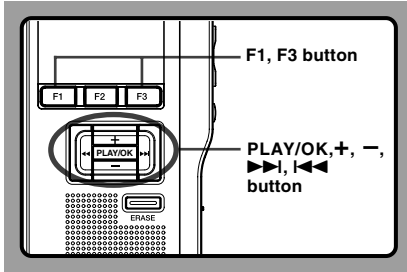

- 1 Select [Cue/Rev Sound] at the [Device Menu] screen, then press the **PLAY/OK** or **>>><<<** button.

Refer to P.34 regarding each menu item settings.

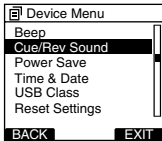

- 2 Press the **+** or **-** button to select [On] or [Off].

**On...**The Cue(Cue)/Review(Rev) playback tone is On.

**Off...**The Cue(Cue)/Review(Rev) playback tone is Off.

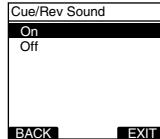

- 3 Press the **PLAY/OK** button to complete the setup screen.

[On Set] or [Off Set] will light up on the display, and it will return to the [Device Menu] screen.

If you press the **<<<** or F1(BACK) button the setting will be cancelled and it will return to the [Device Menu]. Pressing the F3(EXIT) button will cancel the contents being set and take you out of the MENU.

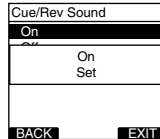

- 4 Press the **F3(EXIT)** or **<<<** button to complete the setting.

# Formatting the Card (Format)

3

Formatting the Card

Cards that have been used in non-Olympus devices, or cards that are not recognized by the recorder, must be formatted before they can be used with the recorder.

To familiarize yourself with the formatting process, read the steps below.

The recorder's menu settings cannot be initialized. The initialization of menu items should be set up through DSS Player or the recorder's [Reset Settings].

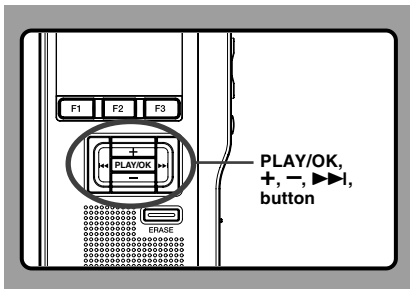

- 1 Select [Device Menu] at the [Format] screen, then press the **PLAY/OK** or **>>>** button.

Refer to P.34 regarding the menu's various setting items.

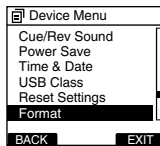

- 2 Press the **+** or **-** button to select [Start] option.

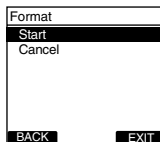

- 3 Press the **PLAY/OK** button to confirm [Start] selection.

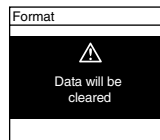

### 4 Press the **+** or **-** button again to select [Start] option.

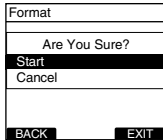

### 5 Press the **PLAY/OK** button again to initiate the formatting process.

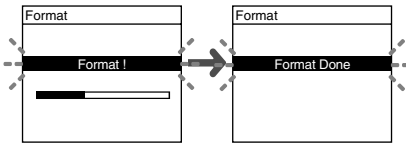

[Format Done] displays when formatting ends.

### Notes

- The time required to format cards differs depending on the capacity of cards. Do not interrupt the formatting process by the following operations. Doing so will damage the data or card.
  - Remove the card.
  - Remove the batteries.
- When the card is formatted, all the stored data, including locked files, are erased.
- If an unformatted card is inserted, the recorder automatically displays the format option in the menu.
- SD cards for which the SD card lock is enabled cannot be initialized.
- Formatting on the recorder will be Quick Format. If you format the card, information of file management is refreshed and the data inside the card is not deleted completely. When handing over and disposing the card, be careful about the data leakage from the card. We recommend the card to be destroyed when you dispose the card.

## Initializing the Recorder's Menu Settings (Reset Settings)

To return the recorder's menu settings to their original status from the time of purchase (initial settings), perform the setting from [Reset Settings] in the [Device Menu], or perform the same operation by using DSS Player.

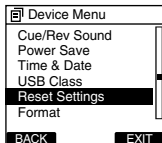

# Check System Information (System Info.)

System information about the recorder like its [Model Name], [Version] and [Serial] can be displayed.

In this recorder, you can check the Card Information (P.9) and File Information (P.37).

2 Press the **PLAY/OK**, **⏪** or **F1 (BACK)** button.

3 Press the **F3(EXIT)** or **⏪** button to complete the setting.

3

Check System Information

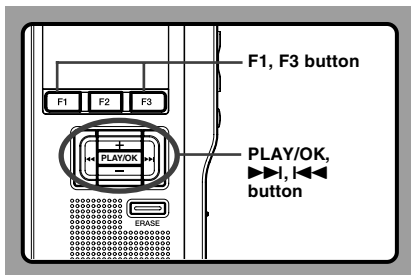

1 Select **[System Info.]** at the **[Device Menu]** screen, then press the **PLAY/OK** or **⏩** button.

[Model Name] [Version] [Serial] will appear.  
Refer to P.34 regarding each menu item settings.

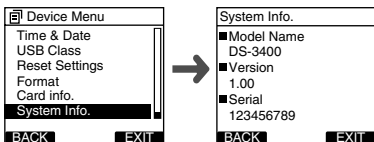



# Changing the USB Class (USB Class)

You can set the USB class of this recorder with a USB connection to [Composite] or [Storage]. Set to [Composite] when using this recorder as a USB speaker or a USB microphone.

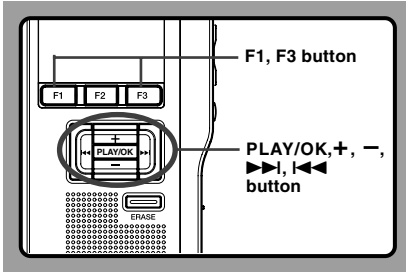

- 1 Select [USB Class] at the [Device Menu] screen, then press the **PLAY/OK** or **>>>** button.

Refer to P.34 regarding each menu item settings.

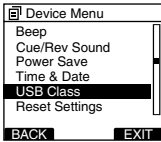

- 2 Press the **+** or **-** button to select [Composite] or [Storage].

**Composite...**In the 3 classes of Storage, USB audio and human interface, USB connection is possible. While USB connection in [composite], the recorder can be used as the USB speaker and the USB microphone.  
**Storage...**USB connection is possible in only Storage class.

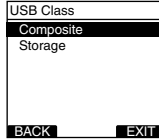

- 3 Press the **PLAY/OK** button to complete the setup screen.

[Composite Set] or [Storage Set] will light up on the display, and it will return to the [Device Menu] screen.

If you press the **<<<** or F1(BACK) button the setting will be cancelled and it will return to the [Device Menu]. Pressing the F3(EXIT) button will cancel the contents being set and take you out of the MENU.

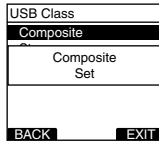

- 4 Press the **F3(EXIT)** or **<<<** button to complete the setting.

When this recorder is connected to the computer for the first time after being changed to "Remote(Composite)", the driver will be installed automatically to the computer.

# Customizing the Recorder

You can customize various specifications of the recorder when using DSS Player (P.59). For more details, refer to the Online help for DSS Player (P.63).

## The Recorder's Customized Settings

### Common Settings

You can set the default values for each of the recorder's Menu items.

### Administrative Settings

#### General

##### Accessibility

You can perform various settings related to user authorization, such as prohibiting both file erasure and MENU settings.

##### Splash Message

You can set the contents that appear in the message which is displayed during startup.

##### Main Button Guide

You can set the Main Button Guide. Main Button Guide shows the Main Button status on the LCD of the recorder.

##### Alarm

You can set occasions for the recorder's alarm or beep noise to sound.

#### Display

- You can select a default pattern for display during recording from 5 patterns.
- On the 2nd line of the LCD, you can display File Name or Work Type instead of Author ID which is currently displayed in the NEW, STOP, REC, PLAY, CUE/REV, FF/REW or ERASE mode.

#### Device Security

You can perform various settings related to the recorder's device lock.

- Device lock function ON/OFF.
- Settings related to the timing for setting the device lock.
- Password settings.
- Changing the number of allowable input errors (mismatches) for the password.

#### Author List

You can perform settings related to the Author, such as Author registration.

#### Work Type List

You can perform settings related to the Work Type, such as Work Type registration.

#### Device Folders

You can perform various settings related to the recorder's folders.

- Changing the number of folders and folder name.
- Auto Lock setting which locks files recorded in designated folders.
- Encryption Password setting which encrypts files recorded in designated folders.
- Work Type settings for each folder.

#### Recording

You can perform various settings related to the recorder's Dictation.

- Recording format (DSS Pro/DSS Classic) selection.
- Recording mode (Overwrite/Append/Insert) setting.
- Settings related to eligible files when downloading to a PC (All files/Finished files).

#### Programmable Buttons

You can change the allocated functions for the Programmable Smart Buttons (F1, F2, F3 buttons).

# 4 Managing Files on Your PC

## DSS Player Software

---

The DSS Player is a fully featured software tool that provides a simple to use but sophisticated method of managing your recordings. Some of the features of the DSS Player are:

- Automatic startup of the application by connecting the device.
- Automatic download of Dictation by connecting the device.
- Backs up downloaded Dictation (Windows only).
- Automatic transmission of downloaded Dictation to addresses specified through e-mail and FTP (Windows only).
- Automatic transmission of transcribed documents through e-mail and FTP, as well as Dictation and link management (Windows only).
- Voice recorder's menu setting.
- Customize functions on the recorder (Windows only).
- Direct recording and editing of existing Dictation through Voice recorder's button.
- Recording Instruction Comments and Verbal comments (Windows only).
- Encrypt the Dictation within the folder by encrypting the folder itself (Windows only).

Make sure that your computer meets the minimum requirements listed below. Please check with your system administrator or your Olympus Professional Dealer.

## Minimum Requirement

---

### Windows

|                             |   |
|-----------------------------|---|
| <b>Operating System:</b>    | Windows 2000 Professional Service Pack 4<br>Windows XP Home edition Service Pack 2,3<br>Windows XP Professional Service Pack 2,3 (32bit/64bit)<br>Windows Vista Home Basic, Service Pack 1 (32bit/64bit)<br>Windows Vista Home Premium, Service Pack 1 (32bit/64bit)<br>Windows Vista Business, Service Pack 1 (32bit/64bit)<br>Windows Vista Enterprise, Service Pack 1 (32bit/64bit)<br>Windows Vista Ultimate, Service Pack 1 (32bit/64bit)<br>Windows Server 2003 (32bit/64bit) |
| <b>CPU:</b>                 | Windows 2000/XP: Intel Pentium III 500MHz processor or more<br>Windows Vista: Intel Pentium III 800MHz processor or more<br>Windows Server 2003: Intel Pentium III 550MHz processor or more   |
| <b>RAM:</b>                 | Windows 2000/XP: 128MB or more (256MB or more recommended)<br>Windows Vista: 512MB or more (1GB or more recommended)<br>Windows Server 2003: 256MB or more  |
| <b>Hard drive space:</b>    | Dictation Module: 70MB or more;<br>(700MB or more with Microsoft .NET Framework Version 2.0 not installed)  |
| <b>Drive:</b>               | CD or DVD drive   |
| <b>Display:</b>             | 800 x 600 pixels or more, 65536 colors more (16.77 million colors or more recommended)  |
| <b>USB port:</b>            | With the Dictation Module: One or more free ports available   |
| <b>Audio I/O terminals:</b> | With the Dictation Module: A Microsoft WDM- or MME-compliant and Windows-compatible sound device  |

### Macintosh

|                          |   |
|--------------------------|---|
| <b>Operating System:</b> | Mac OS X 10.3.9 - 10.5  |
| <b>CPU:</b>              | Power PC G3 500MHz or more/Intel Core Solo/Duo 1.5GHz or more |
| <b>RAM:</b>              | 256MB or more (512MB or more is recommended)                  |
| <b>Hard drive space:</b> | 200MB or more   |
| <b>Display:</b>          | 1024 x 768 pixels or more, 32000 colors more                  |
| <b>USB port:</b>         | One or more free ports  |

### Notes

- Macintosh version does not support voice recognition software.
- Currently supported OS are listed on our Web page. For the latest information, please visit the Olympus Web site at <http://www.olympus-global.com/en/global/>.

# Installing DSS Player Software

## Be sure to confirm the following before installation:

- Exit all running applications.
- Eject the floppy disk/CD/DVD if you are using one.
- If you are running Windows 2000/XP/Vista or Mac OS X on the network, you need to log on as an Administrator.

### Windows

For the Windows version, there is an installation method for individuals and one for administrators to install on multiple client PCs. An explanation of the installation method for individuals installing the software on a single PC will be provided here.

#### 1 Insert Olympus DSS Player CD into the CD-ROM drive.

The installation program will start automatically. If the installation program does not start automatically, browse your CD-ROM drive and execute "launcher.exe".

#### 2 The launcher will startup.

Select the language you would like to install from the upper-left pull-down menu and click [DSS Player Pro Installation].

#### 3 The Install Wizard will begin.

Once you have consented to the licensing agreement, enter your name, company name, and license ID number (serial number). The license ID number is printed on the license ID card included inside the recorder package.

#### 4 Proceed with the installation according to the instructions on the screen.

Select [Select basic settings for DSS Player Wizard] by using [Individual User Settings].

### Macintosh

#### 1 Insert Olympus DSS Player CD into the CD-ROM drive.

#### 2 Double-click the CD icon.

#### 3 Double-click the setup icon.

The Install Wizard will begin. Once you have consented to the licensing agreement, follow the instructions on the screen to complete the installation.

#### 4 Proceed with the installation according to the instructions on the screen.

#### 5 You will be requested to restart, so conduct a restart by following the instructions.

# Uninstalling DSS Player Software

---

## Windows

- 1 Exit DSS Player program.
- 2 Click the [start] button on the taskbar.
- 3 Select [Add/Remove programs] from the [Control Panel].  
A list of installed applications is displayed.
- 4 Select [Olympus DSS Player Pro], then click the [Change/Remove] button.
- 5 Proceed with the uninstallation according to the instructions on the screen.

## Macintosh

- 1 Exit DSS Player program.
- 2 Double-click “DSS Uninstaller” in [Application] → [DSS Player] folder.  
An uninstaller is displayed.
- 3 Proceed with the uninstallation according to the instructions on the screen.

---

### Note

- The dictation files you made are stored in the [MESSAGE] folder. If you don't need them, delete them. You can confirm the location of the [MESSAGE] folder by clicking on [Options] in the [Tools] menu before uninstalling.

# Using Online Help

---

For information on the DSS Player usage and features, refer to the Online help.

To start Online help:

## Windows

- 1 Click the [start] button, then select [All Programs], [Olympus DSS Player Pro], [Dictation Module Help].
- 2 While DSS Player is running, select the [Help] menu, [Contents].
- 3 While DSS Player is running, press F1 on the keyboard.

## Macintosh

While DSS Player is running, select [DSS Player Help] from the [Help] menu.

## Note

- Online help is available after the DSS Player is installed (☞ P.61).

# Connecting Recorder to PC

## 4

### Connecting Recorder to PC

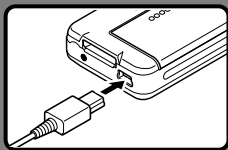
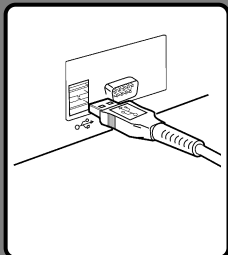

## Connecting to Your PC Using the USB Cable

- 1 Connect the USB cable to the USB port of the PC.
- 2 Confirm that the recorder has stopped and connect a USB cable to the connection port on the recorder.

If [Remote] is displayed on the recorder, it indicates proper connections.

Once you connect the recorder to your PC, the recorder will be powered through the USB cable.

While PC connection, the SD card is recognized as the respective removable disk drive.

## Disconnecting from Your PC

### Windows

- 1 Click the  on the task bar located at the lower-right corner of the screen. Click [Safely Remove Hardware].

The drive letter will differ depending on the PC being used.



1

- 2 Disconnect the USB cable.

### Macintosh

- 1 Move the icon of the recorder's drive displayed on desktop to trash box by drag and drop.

- 2 Disconnect the USB cable.



### Notes

- NEVER remove the card or disconnect the USB cable while the record indicator light is flashing. If you do, the data on the card will get destroyed.
- Some PC's may not supply sufficient power and the recorder fails to connect. Refer to your PC User's Manual regarding the USB port on your PC.
- Do not connect the recorder to a PC by using a USB hub. Make sure to connect to a USB port on your PC.
- Make sure to push the cable connector all the way in. Otherwise, the recorder may not operate properly.
- This is an operational environment for saving the files recorded by this recorder to your PC with USB connection.
- Even if operational environment is satisfied, we do not support upgraded OS, the multi-boot environment or self-modified computers.

# Running DSS Player Software

By default, connecting the recorder to your PC, will start the application automatically. Connect to your PC Using the Cradle.

## Windows

### Disabling Automatic Start

- 1 **Right-click the Device Detector in the System Tray in the lower right-hand corner of the screen, then select [Settings...].**
- 2 **Click [DSS Player Pro Dictation Module].**  
The check mark on [DSS Player Pro Dictation Module] disappears.

### Manual Start

- 1 **Click the [start] button, then select [All Programs].**  
All program menu will be displayed.
- 2 **Select [Olympus DSS Player Pro], then click [Dictation Module].**

## Macintosh

### Disabling Automatic Start

- 1 **Click the Dock's System Preferences.**
- 2 **Click Device Detector.**
- 3 **Turn the automatic startup setting Off.**

### Manual Start

- 1 **Double click the DSS Player icon for the folder in [Application] → [DSS Player].**  
All program menu will be displayed.
- 2 **Register user information.**  
The user's registration screen will be displayed at the time of initial startup. Please input the serial number. Please see the seal attached to the CD-ROM package included with the DSS Player, for the serial number. After the input has ended, click [OK] to complete the registration.

## 5 Other Practical Use Methods

### Using as External Memory of the Computer

---

When the recorder is connected to your PC, it will be recognized on your PC as a removable drive. You can view and access the recorder card from My Computer and download data from the card to your PC using standard windows copy/move and delete commands. You can also upload data from the PC to the card in the recorder in the same way.

#### **Example: Copying Data from PC to Card Using Explorer or Finder**

---

- 1 Connecting the recorder to your PC.**  
For connection procedure, refer to "Connecting to Your PC Using the USB Cable" (P.64).
- 2 Open Windows Explorer or Finder window.**  
[Removable disk] is displayed.
- 3 Copy the data.**  
While the data are being written or copied, the record/play indicator light on the recorder will flash.
- 4 Unplug the recorder from a computer.**

---

#### **Note**

- NEVER remove the card or disconnect the USB cable while the record indicator lamp is flashing. If you do, the data on the card will get destroyed.

## 6 Other Information

### Alarm Message List

| Message                 | Explanation   | Action   |
|-------------------------|---|--|
| <b>Battery Low</b>      | Battery power is getting low.   | Replace with new batteries (☞ P.12).   |
| <b>File Protected</b>   | Attempt to delete a locked file.                                      | Unlock the file (☞ P.40).  |
| <b>Index Full</b>       | The file is full of index marks (maximum of 32 marks).                | Erase index marks that are no longer required (☞ P.47).                                    |
| <b>Folder Full</b>      | The folder is full of files (maximum of 200 files).                   | Erase unnecessary files (☞ P.29).  |
|                         | The destination folder already has the maximum number of files (200). | Erase unnecessary files (☞ P.29).  |
| <b>Erase Error</b>      | An error occurred while erasing.                                      | Erase once again.<br>When an Erase Error occurs format the card                            |
| <b>Card Error</b>       | An incompatible card was inserted.                                    | Insert a compatible card (☞ P.16).   |
| <b>Unsupported Card</b> | The card cannot be used with this recorder.                           | Please remove the card.  |
| <b>Memory Full</b>      | The card has no remaining memory.                                     | Erase files that are no longer required or insert another card.                            |
| <b>Format Error</b>     | There was an error while formatting the card.                         | Reformat the card (☞ P.54).  |
| <b>System Error</b>     | System error detected in the recorder.                                | This is a malfunction. Contact the place of purchase or Olympus Service Center for repair. |
| <b>Insert Card</b>      | There is no card inserted.  | Insert a card (☞ P.16).  |

# Troubleshooting

| Symptom                               | Probable cause  | Action   |
|---------------------------------------|---|--|
| <b>Nothing appears on the display</b> | The batteries are not loaded properly.  | Verify polarity is correct (☞ P.12).   |
|                                       | The batteries are dead.   | Replace with new batteries (☞ P.12).   |
|                                       | The recorder is in power off mode.  | Turn the recorder ON (☞ P.14).   |
| <b>Won't start</b>                    | The recorder is in power off mode.  | Turn the recorder ON (☞ P.14).   |
|                                       | The batteries are dead.   | Replace with new batteries (☞ P.12).   |
| <b>Unable to record</b>               | The card does not have enough memory.   | Erase unnecessary files or insert another card (☞ P.16, 29).                               |
|                                       | The card is unformatted.  | Format the card (☞ P.54).  |
|                                       | The maximum number of files has been reached.   | Check another folder.  |
|                                       | The SD card is locked.  | Unlock the SD card lock (☞ P.8).   |
| <b>No playback tone heard</b>         | The earphone is connected.  | Unplug the earphones to use the internal speaker.  |
|                                       | The volume level is set to 0.   | Adjust the + (Volume) button.  |
| <b>Unable to erase</b>                | The file is locked.   | Unlock the file (☞ P.40).  |
|                                       | The SD card is locked.  | Unlock the SD card lock (☞ P.8).   |
| <b>Noise heard during playback</b>    | The recorder was shaken during recording.   |  |
|                                       | The recorder was placed near a cell phone or fluorescent lamp while recording or during playback. | Move the recorder.   |
| <b>Recording level too low</b>        | The microphone sensitivity is too low.  | Set the microphone sensitivity to Conference mode and try again (☞ P.23).                  |
| <b>Unable to set index marks</b>      | The maximum number of index marks (32) has been reached.  | Erase unnecessary index marks (☞ P.47).  |
|                                       | The file is locked.   | Unlock the file (☞ P.40).  |
|                                       | The SD card is locked.  | Unlock the SD card lock (☞ P.8).   |
| <b>Cannot find the recorded file</b>  | Wrong folder.   | Switch to the right folder.  |
| <b>Cannot connect to a PC</b>         | Sometimes a connection cannot be made with some PCs running Windows XP or Vista.                  | You need to change the PC's USB settings. See DSS Player Online help for details (☞ P.63). |

# Accessories

---

## **Headset: E62, E102**

Stereo headset for your PC. A helpful tool for PC based transcription.

## **Monaural binaural earphone: E20**

### **Noise-cancellation microphone: ME12 (Dictation microphone)**

Used to get crisp recordings of your own voice by reducing the effects of ambient noise. Recommended to improve the accuracy when using voice-recognition software.

### **External microphone: ME15**

A lavalier omnidirectional microphone that clips to clothing. Used to record your own voice or people near you.

### **Highly sensitive noise-cancellation monaural microphone: ME52W**

This microphone is used to record sound at a distance while minimizing surrounding noise.

### **PC transcription kit: AS-5000**

The AS-5000 transcription kit provides you with a PC-footswitch, a headset and DSS Player Pro Transcription Module for easy transcription of DSS recordings.

### **Connecting cord: KA333**

Use to connect the microphone jack of this unit to a radio or other sound source.

### **Telephone pickup: TP7**

Earphone type microphone can be plugged into your ear while phoning. The voice or conversation over the phone can be clearly recorded.

### **Ni-MH rechargeable battery and charger set: BC400 (Europe only)**

BC400 comes with an Ni-MH rechargeable battery charger (BU-400) and 4 Ni-MH rechargeable batteries (BR401) as a pack. This charger can quick charge Olympus AA or AAA Ni-MH rechargeable batteries.

### **Ni-MH rechargeable battery: BR401**

High-efficiency rechargeable long life batteries.

# Specifications

---

## **Recording format**

DS2 (Digital Speech Standard Pro)

## **Recording media**

SD-card: 512 MB to 16 GB

## **Input level** -70 dBv

## **Sampling frequency**

QP mode: 16 kHz

SP mode: 12 kHz

## **Overall frequency response**

QP mode: 200 to 7,000 Hz

SP mode: 200 to 5,000 Hz

## **Recording time (1 GB Card)**

QP mode: 77 hours 00 minutes

SP mode: 157 hours 50 minutes

## **Alkaline battery life**

### **Recording:**

QP mode: Approx. 24 hours

SP mode: Approx. 30 hours

### **Playback:**

All mode: Approx. 13 hours

## **Speaker**

Built-in  $\varnothing$ 23mm round dynamic speaker

## **MIC/EAR jack**

$\varnothing$ 3.5 mm mini-jack, impedance

MIC 2 k $\Omega$ , EAR 8  $\Omega$  or more

## **Maximum working output (3 V DC)**

250 mW or more (8  $\Omega$  speaker)

## **Input power requirement**

Rated voltage: 5 V

Batteries: Two AAA batteries (LR03) or

Two OLYMPUS Ni-MH

rechargeable batteries

## **External dimensions**

113.5 x 50.0 x 17 mm

(without protrusions)

## **Weight**

105 g (Including alkaline batteries)

\* Specifications and design are subject to change without notice.

\* Battery life is measured by Olympus. It varies greatly according to the type of batteries used and the conditions of use.

# Technical Assistance and Support

---

DS-3400 is part of the Olympus Professional Dictation System. Your dealer is trained to troubleshoot and fix many common problems that you may be having with this system. If you encounter problems using your DS-3400, we recommend that you contact your Olympus Professional Dealer that sold you the system. If your dealer cannot fix your problem, please call our technical hotline number or send an E-mail.

- ◆ For customers in the U.S. and Canada  
Phone: 1-888-553-4448  
E-mail: [distec@olympus.com](mailto:distec@olympus.com)
- ◆ For customers in Europe  
E-mail : [dss.support@olympus-europa.com](mailto:dss.support@olympus-europa.com)







## For customers in Europe



“CE” mark indicates that this product complies with the European requirements for safety, health, environment and customer protection.



This symbol [crossed-out wheeled bin Directive 2006/66/EC Annex II] indicates separate collection of waste batteries in the EU countries. Please do not throw the batteries into the domestic refuse. Please use the return and collection systems available in your country for the disposal of the waste batteries.



This symbol [crossed-out wheeled bin WEEE Annex IV] indicates separate collection of waste electrical and electronic equipment in the EU countries. Please do not throw the equipment into the domestic refuse. Please use the return and collection systems available in your country for the disposal of this product.



Applicable Product: DS-3400



L'indication “CE” signifie que ce produit est conforme aux exigences concernant la sécurité, la santé, l'environnement et la protection du consommateur.



Ce symbole [Poubelle rayée conformément à la directive annexe 2006/66/EC annexe II] indique que la collecte des batteries usagées se fait séparément dans les pays EU. Veuillez ne pas jeter les batteries dans les ordures ménagères. Veuillez utiliser les systèmes de collection disponibles dans votre pays pour l'enlèvement des batteries usagées.



Le symbole [poubelle sur roue barrée d'une croix WEEE annexe IV] indique une collecte séparée des déchets d'équipements électriques et électroniques dans les pays de L'UE. Veuillez ne pas jeter l'équipement dans les ordures domestiques. A utiliser pour la mise en rebut de ces types d'équipements conformément aux systèmes de traitement et de collecte disponibles dans votre pays.



Produit applicable: DS-3400



La marca “CE” indica que este producto cumple con los requisitos europeos en materia de seguridad, salud, medio ambiente y protección al consumidor.



Este símbolo [Directiva 2006/66/EC Anexo II sobre contenedores] indica que se deben separar las pilas usadas en los países de la UE. Por favor no tire las pilas en la basura normal. Por favor utilice los sistemas de reciclaje que existan en su país para tirar las pilas.



Este símbolo [un contenedor de basura tachado con una X en el Anexo IV de WEEE] indica que la recogida de basura de equipos eléctricos y electrónicos deberá tratarse por separado en los países de la Unión Europea. No tire este equipo a la basura doméstica. Para el desecho de este tipo de equipos utilice los sistemas de devolución al vendedor y de recogida que se encuentren disponibles.



Producto aplicable: DS-3400

# OLYMPUS®

## OLYMPUS IMAGING CORP.

Shinjuku Monolith, 3-1 Nishi-Shinjuku 2-chome, Shinjuku-ku, Tokyo 163-0914, Japan. Tel. 03-3340-2111

<http://www.olympus.com>

## OLYMPUS IMAGING AMERICA INC.

3500 Corporate Parkway, P.O.Box 610, Center Valley, PA 18034-0610, U.S.A. Tel. 1-888-553-4448

<http://www.olympusamerica.com>

## OLYMPUS IMAGING EUROPA GMBH

(Premises/Goods delivery) Wendenstrasse 14-18, 20097 Hamburg, Germany. Tel. 040-237730

(Letters) Postfach 10 49 08. 20034 Hamburg, Germany.

<http://www.olympus-europa.com>

## OLYMPUS UK LTD.

Vision House 19 Colonial Way Watford Herts WD24 4JL. Tel.01923-83-1000

<http://www.olympus.co.uk>

## For customers in North and South America

### *Declaration of Conformity*

|                    |   |
|--------------------|---|
| Model Number:      | DS-3400   |
| Trade Name:        | DIGITAL VOICE RECORDER  |
| Responsible Party: | OLYMPUS IMAGING AMERICA INC.  |
| Address:           | 3500 Corporate Parkway, P.O. Box 610, Center Valley, PA 18034-0610,<br>U.S.A. |
| Telephone Number:  | 1-888-553-4448  |

This device Complies with Part 15 of the FCC Rules. Operation is subject to the following two conditions: (1) This device may not cause harmful interference, and (2) this device must accept any interference received, including interference that may cause undesired operation.

 Tested To Comply  
With FCC Standards

FOR HOME OR OFFICE USE

## Canadian RFI

This digital apparatus does not exceed the Class B limits for radio noise emissions from digital apparatus as set out in the Radio Interference Regulations of the Canadian Department of Communications.

Cet appareil numérique ne dépasse pas les limites de Catégorie B pour les émissions de bruit radio émanant d'appareils numériques, tel que prévu dans les Règlements sur l'Interférence Radio du Département Canadien des Communications.